

NA NAVARRO
AZORÍN

50 años
years
old

1967 – 2017

2018

NA NAVARRO
AZORÍN

ARTE, DISEÑO Y MATERIA

ART, DESIGN AND MATTER

ART, DESIGN ET MATIÈRE

N O S O T R O S

U S

N O U S

Ahora que celebramos el 50 cumpleaños de NAVARRO AZORÍN y vemos la necesidad de recopilar en un catálogo los principales artículos que fabricamos somos conscientes del largo periodo de aprendizaje por el que hemos transitado.

Y es que si por algo se distingue NA es por haber sabido escuchar tanto a los mercados como a sus clientes. De este modo, con el paso de los años, además de una clientela fiel, hemos logrado tener una posición respetable entre los fabricantes del sector.

Now that we celebrate the 50th birthday of NAVARRO AZORÍN and we need to compile into a catalogue the main items that we produce, we are aware of the long learning period through which we have traveled.

The fact is that if there is something where NA is distinguished, it is for having been able to hear to both the markets and our customers. Thus, over the years, along with a loyal clientele, we have gained a respectable position among the manufacturers in our industry.

Maintenant que nous fêtons le 50e anniversaire de NAVARRO AZORÍN, et alors que nous imprimons un catalogue de nos principaux produits, nous mesurons la longue période d'apprentissage parcourue.

Navarro Azorín se distingue par le fait d'être à l'écoute à la fois du marché du meuble et de ses clients. Ainsi, au fil des ans, nous avons acquis une clientèle fidèle et une position respectable parmi les fabricants.

NA NAVARRO
AZORÍN

www.na-spain.com

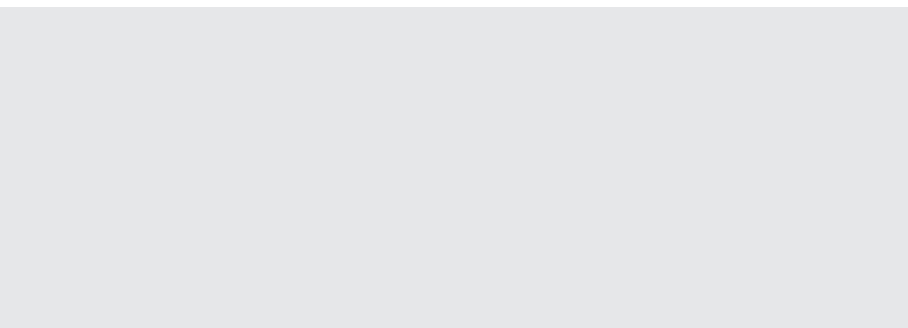
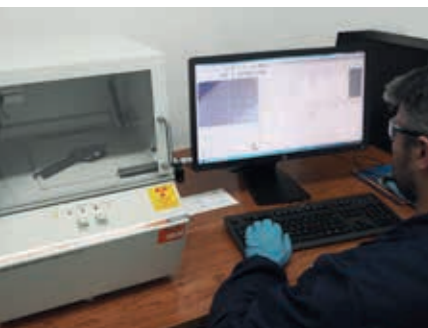
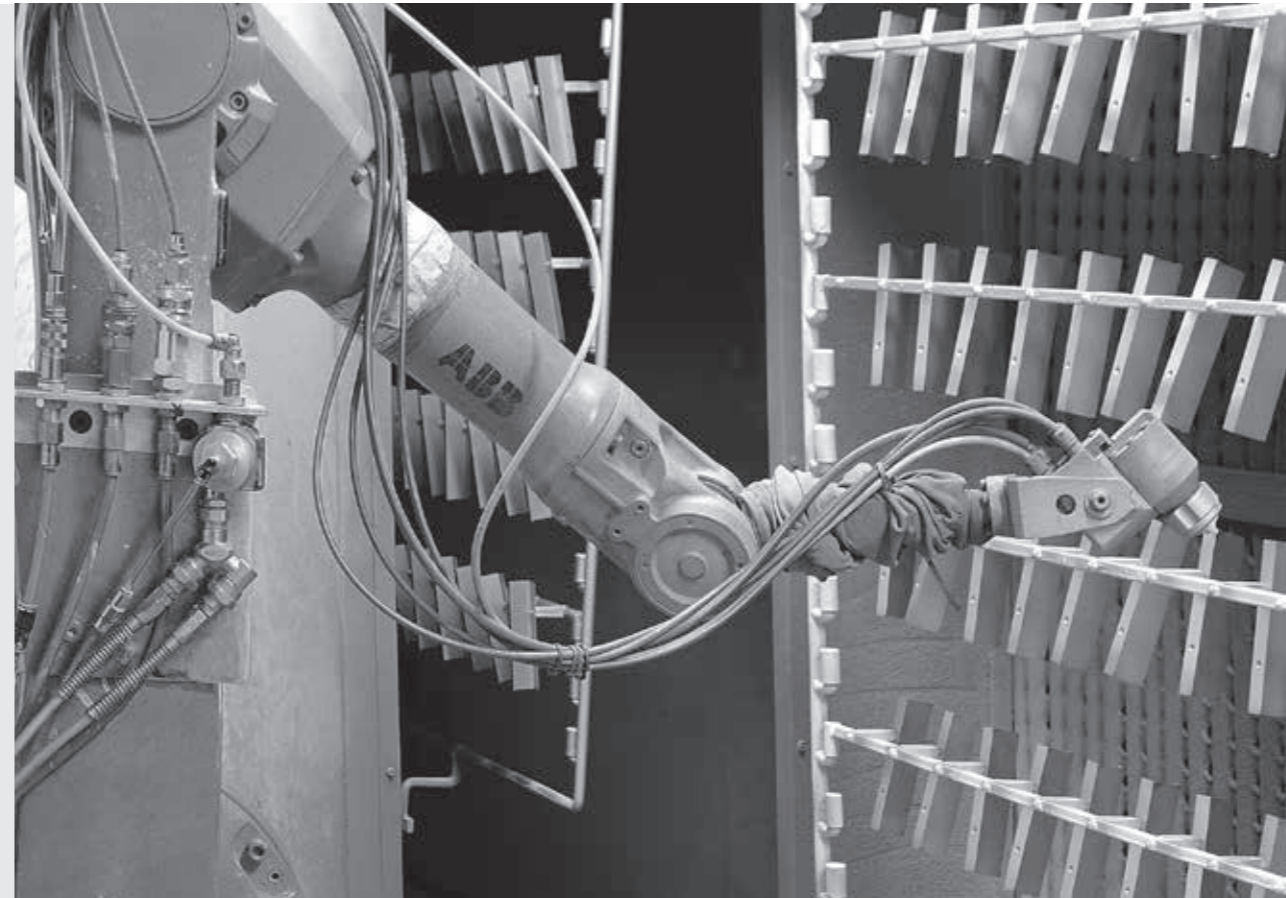

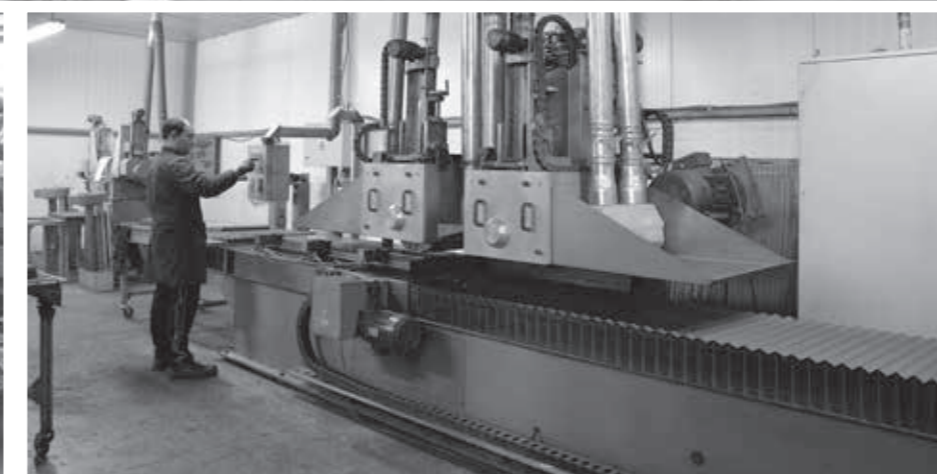
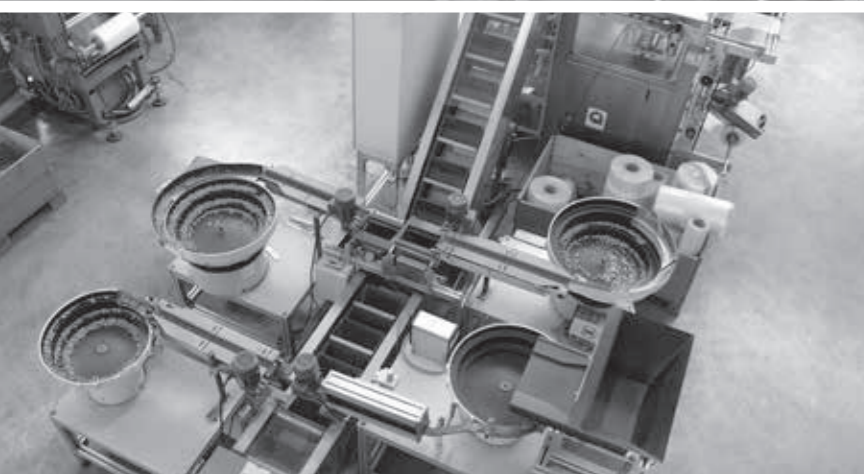
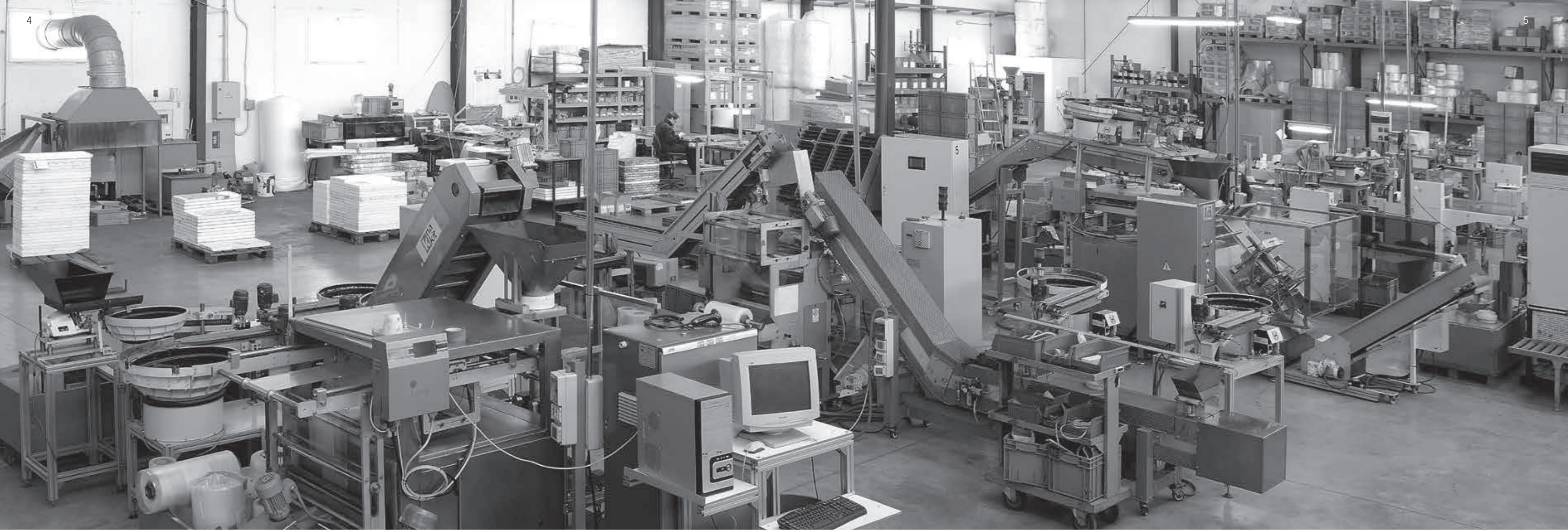

ACABADOS / FINISHES / FINITIONS

GRUPO 1 - BAÑOS CLÁSICO ZAMACK / CLASSIC FINISHES / FINITIONS CLASSIQUES ZAMACK



001 CUERO ANTIQUE BRASS BRONZE VIEILLI
002 CUERO PLB (OLD BRASS) PLB-BRONZE VIE
016 PLATA VIEJA OLD SILVER ARG. VIEILLI
018 COBRE ENVEJECIDO OLD COPPER CUIVRE VIEILLI

GRUPO 2 - BAÑOS ZAMAK / CONTEMPORARY FINISHES / FINITIONS ZAMAK



017 NIQUEL SEDA SILK NICKEL NICKEL SOIE
023 CROMO MATE MATT CHROME CHROME MAT
026 CROMO BRILLO SHINY CHROME CHROME BRILLANT
043 COBRE MATE MATT COPPER CUIVRE MAT

GRUPO 3 - ALUMINIOS / ALUMINIUM / ALUMINIUM



026 CROMO BRILLO SHINY CHROME CHROME BRILLANT
030 ANODIZADO MATE PLUS MATT ANODIZED PLUS ANODISE MAT PLUS
032 ANODIZADO BRILLO SHINY ANODIZED. ANODISE BRILLANT
033 ANODIZADO INOX STAINLESS ANOD. ANODISE INOX
034 ANODIZADO NEGRO MATE MATT BLACK ANODIZED ANODISE NOIR MAT
039 ANODIZADO NEGRO BRILLO SHINY BLACK ANODIZED ANODISE NOIR BRILLANT

GRUPO 4 - PINTURA PARA METÁLICOS / METALLIC PAINT / FINITIONS LAQUEES POUR METAL



020 EFECTO MATE MATT EFFECT EFFET MAT
021 EFECTO CROMO CHROME EFFECT EFFET CHROME
425 VULCANO VULCANO VULCANO
866 COBRE CHILE CHILI COPERR CUIVRE CHILI
916 NEGRO GRAFITO GRAPHITE BLACK NOIR GRAPHITE
865 NEGRO COBALTO COBALT BLACK NOIR COBALT
744 BLANCO WHITE BLANC

GRUPO 5 - ABS COLORES / ABS COLOURS / ABS LAQUE COLEURS





747 PIZARRA SLATE ARDOISE
874 TEJA GABLE TUILE
737 BEIGE BEIGE BEIGE
656 VERDE SOFT 2 GREEN SOFT 2 VERT SOFT 2
745 FUCSIA FUCSIA FUCHSIA
427 ROJO RED ROUGE
746 MORA BLACKBERRY MURE



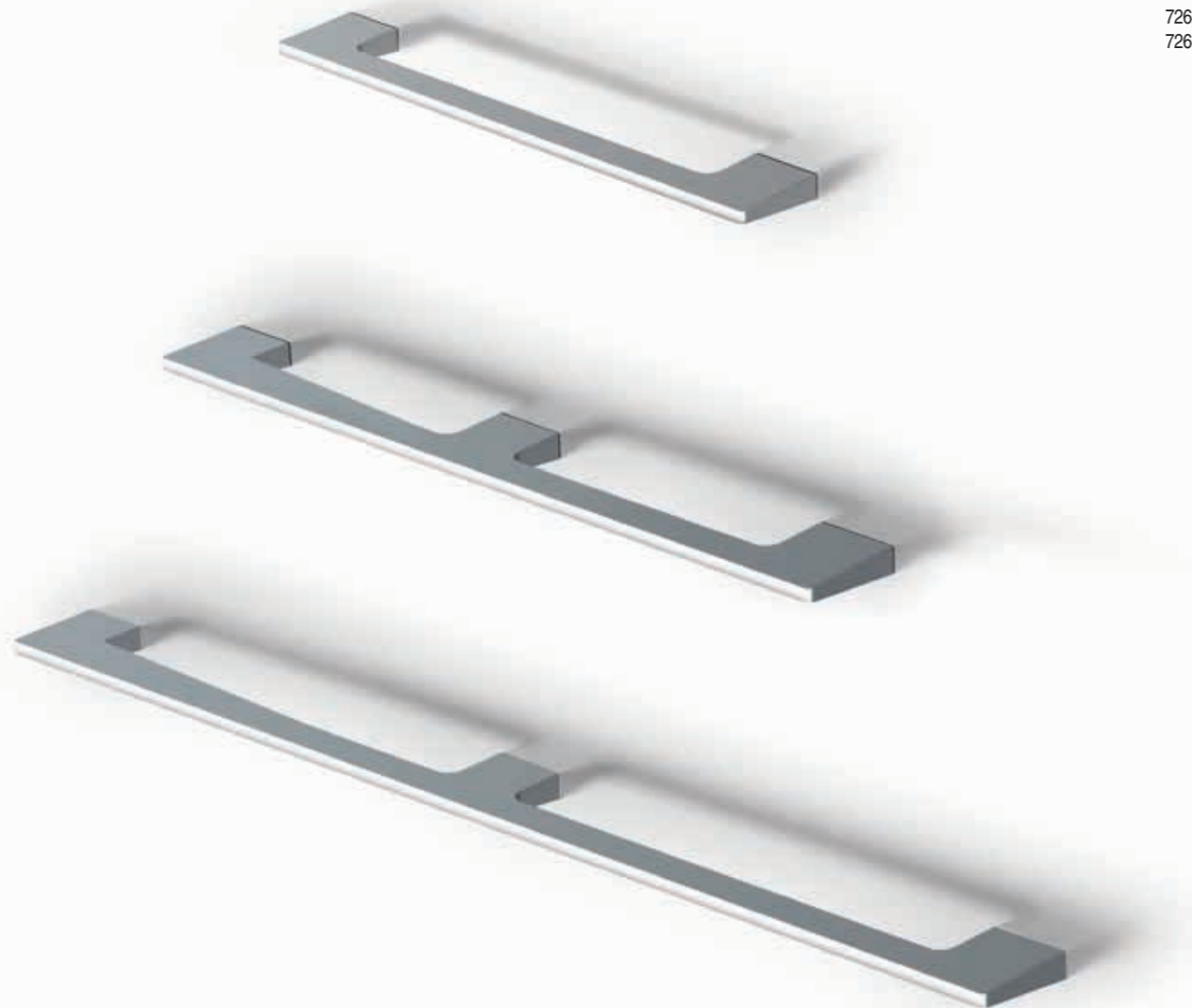

870 COBALTO COBALT COBALTE
801 ROSA PINK ROSE
422 GRIS CLARO LIGHT GREY GRIS CLAIR
800 LAGO BLUE LAKE BLEU LAC
875 CACAO COCOA CACAO
799 CIELO SKY BLUE BLEU CIEL
871 OCRE OCHER OCRE

DESIGN AL

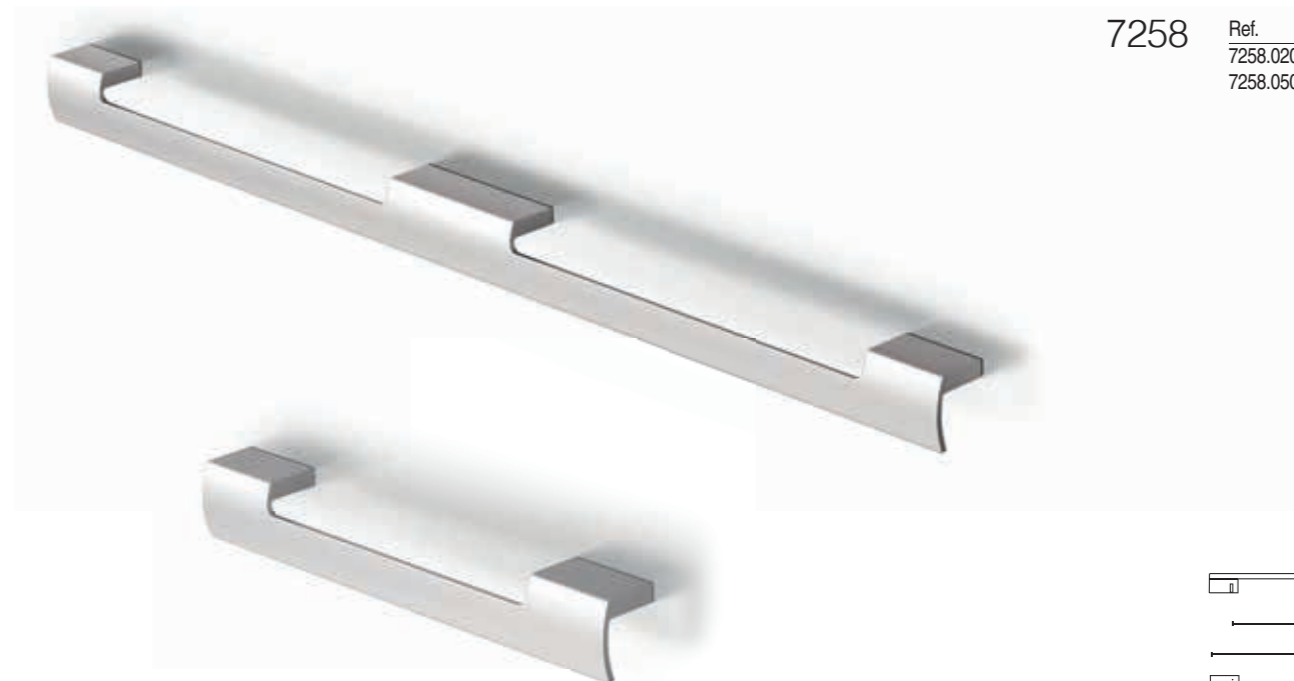
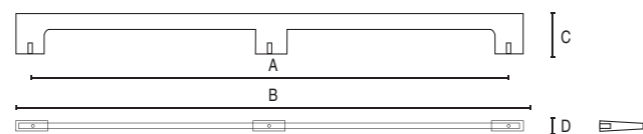
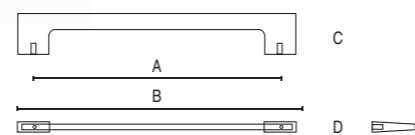

7264	Ref.	A	B	C	D	
	7264.0217	192	217	32	4	20
	7264.0409	192-192	409	32	4	15
	7264.0601	288-288	601	32	4	10



7258	Ref.	A	B	C	D	
	7258.0200	160	200	23	29	20
	7258.0500	224-224	500	23	29	10

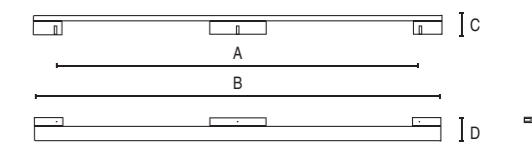
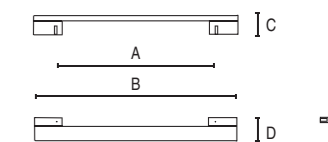

LANCE

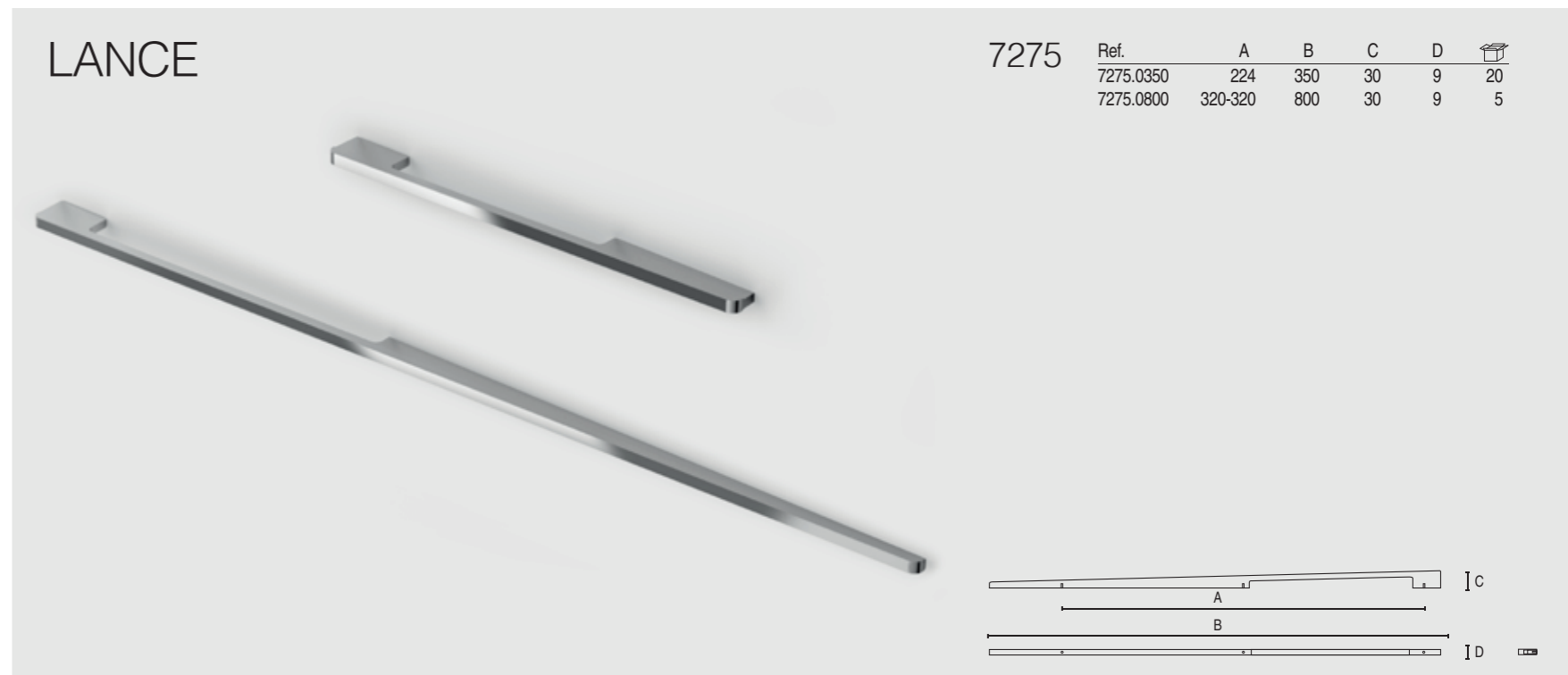

7275	Ref.	A	B	C	D	
	7275.0350	224	350	30	9	20
	7275.0800	320-320	800	30	9	5

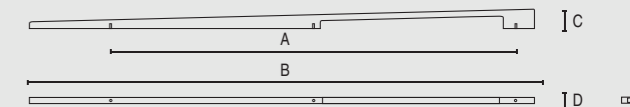

ONA

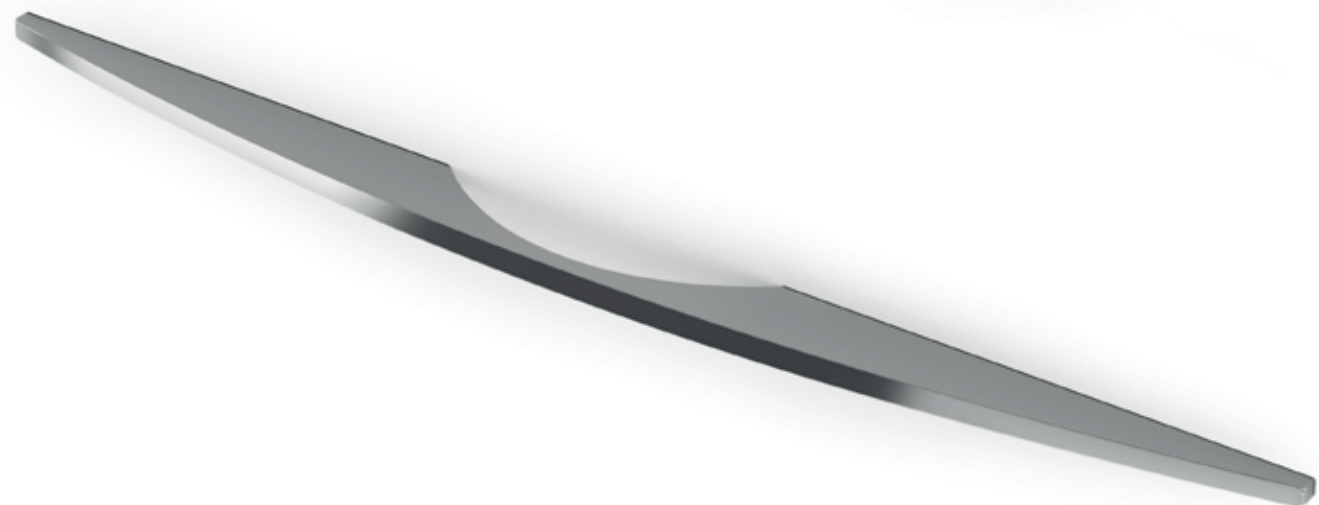
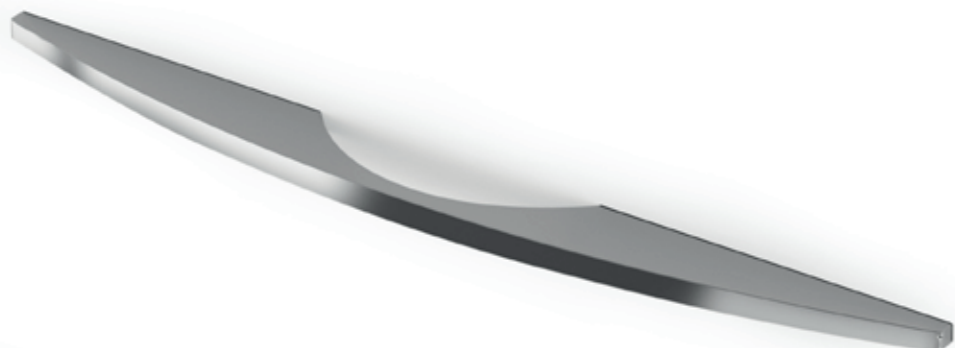
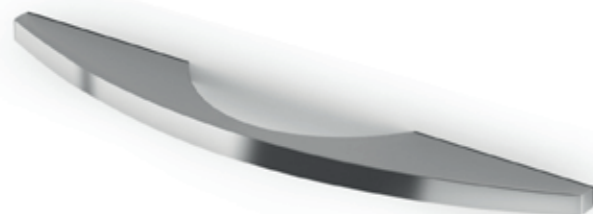
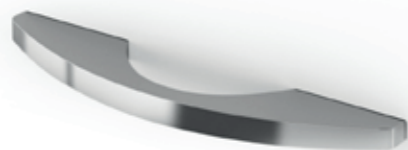

7314	Ref.	A	B	C	D	
	7314.0200	128	200	30	12	20
	7314.0300	192	300	35	12	20
	7314.0500	64-320-64	500	35	12	10
	7314.0700	160-320-160	700	35	12	5

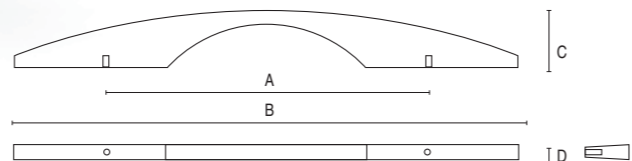

OCHENTA



8080	Ref.	A	B	C	D	
	8080.0096	96	160	30	9	25
	8080.0128	128	192	30	9	25
	8080.0160	160	224	30	9	25
	8080.0192	192	256	30	9	20
	8080.0242	242	306	30	9	20
	8080.0292	292	356	30	9	15
	8080.0342	342	406	30	9	15
	8080.0392	392	456	30	9	15

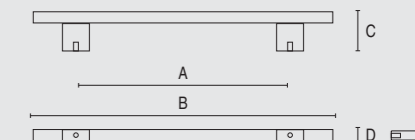

8080	Ref.	A	B	C	D	
	8080.0492	246-246	556	30	9	10
	8080.0592	296-296	656	30	9	10
	8080.0692	346-346	756	30	9	5
	8080.0792	396-396	856	30	9	5

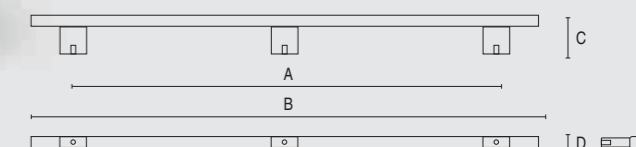

8080	Ref.	A	B	C	D	
	8080.0992	330,6-330,6-330,6	1056	30	9	5

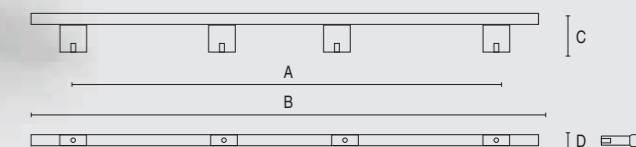

THAMES



7315

Ref.	A	B	C	D	
7315.0300	224	300	40	8	20
7315.0500	440-320	500	40	8	10
7315.1000	960-320	1000	40	8	5

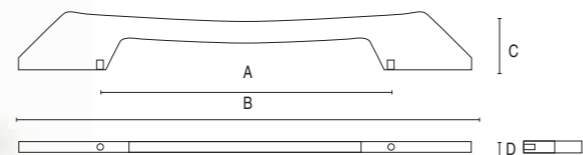

7C95

Ref.	A	B	C	D	
7C95.0150	96	150	20	30	100
7C95.0300	256	300	20	30	50

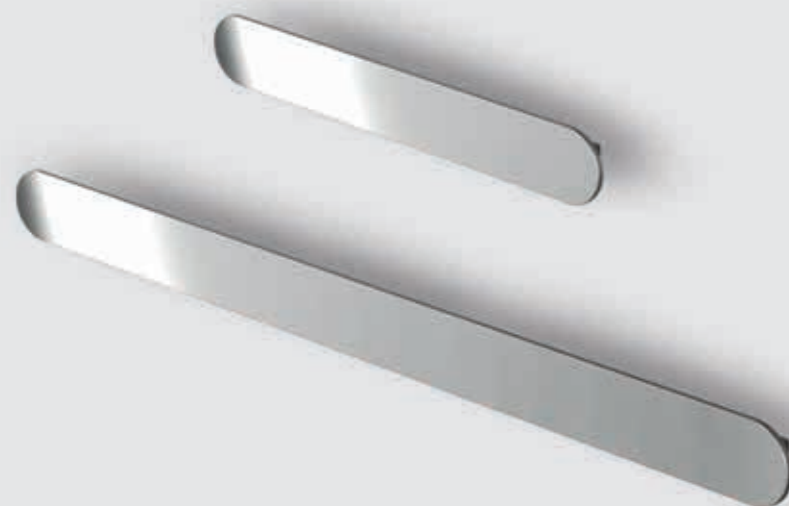
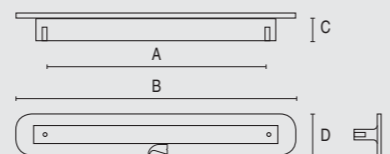

7171

Ref.	A	B	C	D	
7171.0210	160	210	30	9	25
7171.0300	224	300	30	9	25
7171.0500	448	500	30	9	25

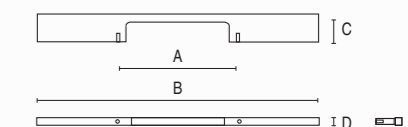
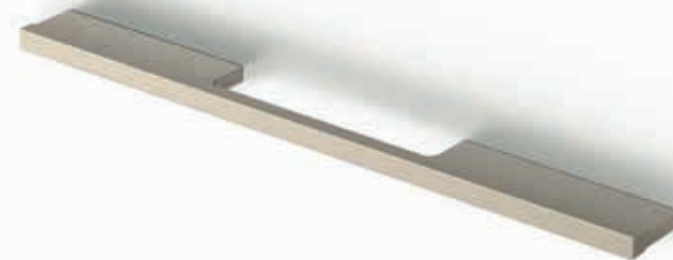

7278

Ref.	A	B	C	D	
7278.0050	32	50	15	40	200
7278.0200	128	200	15	40	200
7278.0400	320	400	15	40	200

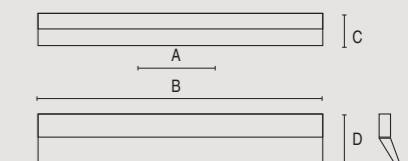



7239	Ref.	A	B	C	D	
	7239.0200	96	200	23	3	200
	7239.0300	128	300	23	3	200
	7239.0500	320	500	23	3	200

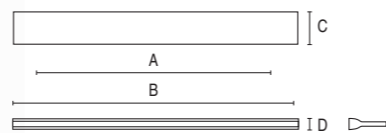

7191	Ref.	A	B	C	D	
	7191.0072	32	72	14	7	200
	7191.0104	64	104	14	7	200
	7191.0168	64	168	14	7	200
	7191.0200	96	200	14	7	200
	7191.0400	96-192	400	14	7	200

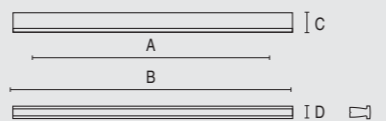

7240	Ref.	A	B	C	D	
	7240.0064	64	150	23	25	200
	7240.0128	128	300	23	25	200
	7240.0320	320	450	23	25	200

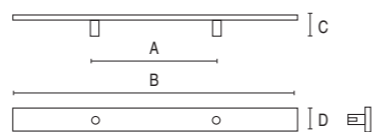

7797	Ref.	A	B	C	D	
	7797.0072	32	72	20	10	200
	7797.0136	64	136	20	10	200
	7797.0300	128	300	20	10	200
	7797.0500	192	500	20	10	200

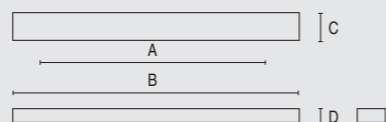

PALA



7392	Ref.	A	B	C	D	
	7392.0200	128	200	16,5	6,5	200
	7392.0400	320	400	16,5	6,5	200
	7392.0600	320	600	16,5	6,5	100
	7392.0800	320-320	800	16,5	6,5	50

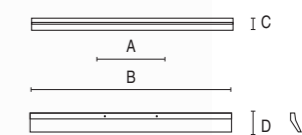

TANA

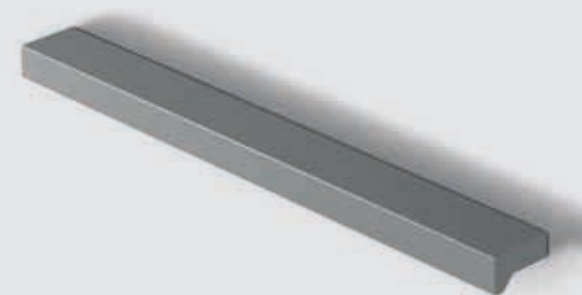

7388	Ref.	A	B	C	D	
	7388.0100	96	100	20	11	200
	7388.0190	160	190	20	11	200
	7388.0300	256	300	20	11	200
	7388.0380	320	380	20	11	200

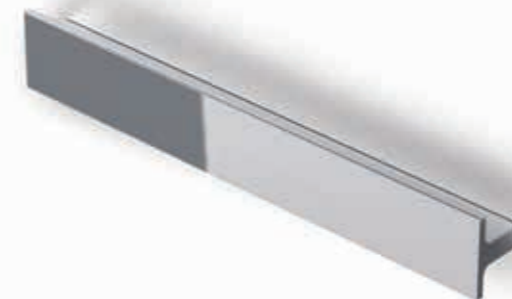
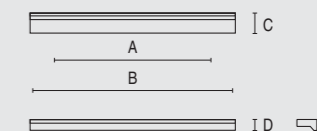

7245	Ref.	A	B	C	D	
	7245.0030	16	30	20	30	200
	7245.0150	64	150	20	30	200
	7245.0300	192	300	20	30	200
	7245.0500	320	500	20	30	200

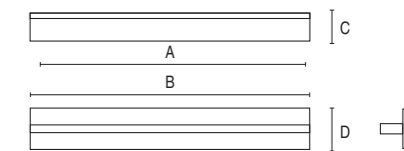

7246	Ref.	A	B	C	D	
	7246.0050	32	50	20	50	200
	7246.0150	64	150	20	50	200
	7246.0250	192	250	20	50	200
	7246.0400	160-160	400	20	50	200

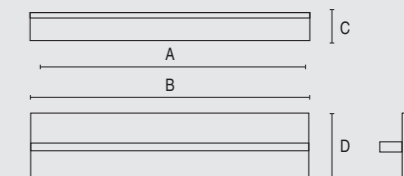

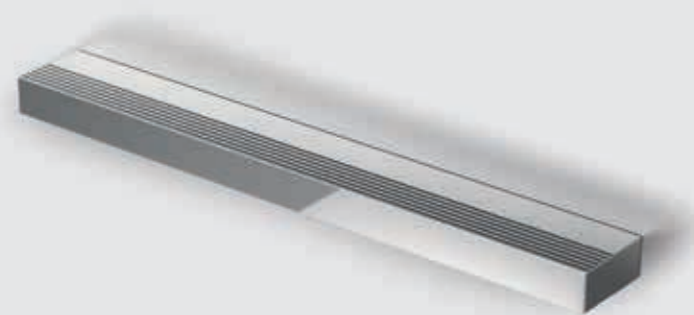

7229

Ref.	A	B	C	D	
7229.0200	96	200	26	12	200
7229.0400	320	400	26	12	200
7229.0800	320-320	800	26	12	100

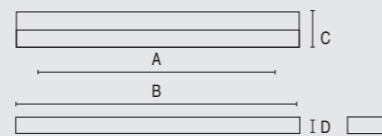

7216

Ref.	A	B	C	D	
7216.0100	64	100	12	21	200
7216.0200	64	200	12	21	200
7216.0400	128	400	12	21	200
7216.1000	320-320-320	1000	12	21	25

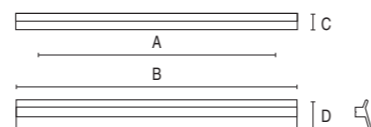

7192

Ref.	A	B	C	D	
7192.0200	128	200	17	9	200
7192.0400	192	400	17	9	200
7192.0800	256-192-256	800	17	9	100

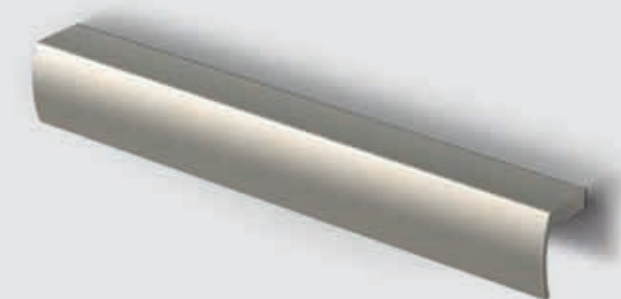
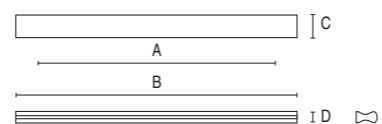

7154

Ref.	A	B	C	D	
7154.0200	96	200	23	29	25
7154.0300	128	300	23	29	25
7154.0500	192	500	23	29	25

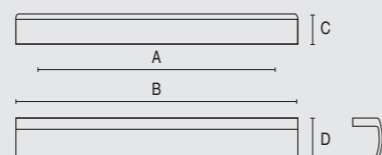

7069

Ref.	A	B	C	D	
7069.0104	64	104	15	7	200
7069.0250	64	250	15	7	200
7069.0400	192	400	15	7	200
7069.0700	320-320	700	15	7	100

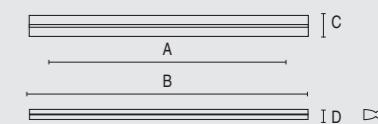

7C10

Ref.	A	B	C	D	
7C10.0150	128	150	18	14	200
7C10.0220	192	220	18	14	200
7C10.0300	256	300	18	14	200
7C10.0600	320	600	18	14	100

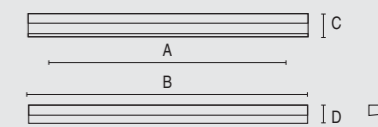

7C08

Ref.	A	B	C	D	
7C08.0150	64	150	18	12	200
7C08.0300	128	300	18	12	200
7C08.0450	320	450	18	12	200
7C08.0900	320-320	900	18	12	50

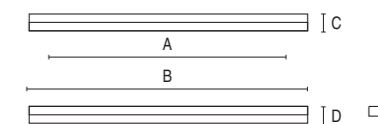

7093

Ref.	A	B	C	D	
7093.0136	64	136	16	16	200
7093.0200	64	200	16	16	200
7093.0400	192	400	16	16	200
7093.0700	320-320	700	16	16	100

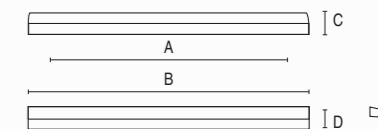



7287 Ref.	A	B	C	D	
7287.0050	32	50	16	26	200
7287.0150	64	150	16	26	200
7287.0300	128	300	16	26	200
7287.0600	320	600	16	26	100

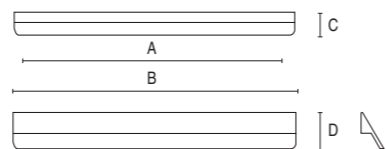

7783 Ref.	A	B	C	D	
7783.0045	32	45	16	16	200
7783.0104	64	104	16	16	200
7783.0200	64	200	16	16	200
7783.0500	192	500	16	16	200

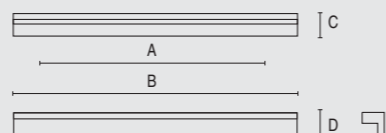

7279 Ref.	A	B	C	D	
7279.0050	32	50	15	30	200
7279.0150	96	150	15	30	200
7279.0200	128	200	15	30	200
7279.0400	320	400	15	30	200

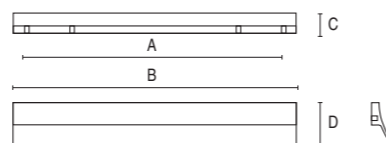

7233 Ref.	A	B	C	D	
7233.0200	128	200	22	35	200
7233.0250	128	250	22	35	200
7233.0400	320	400	22	35	200

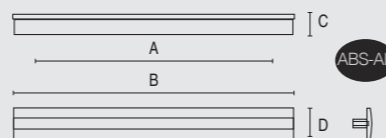

7274 Ref.	A	B	C	D	
7274.0170	32	170	20	30	200
7274.0300	128	300	20	30	200
7274.0500	320	500	20	30	200

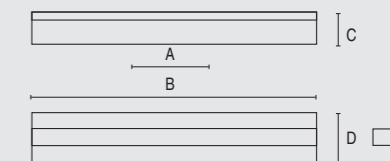

7B90 Ref.	A	B	C	D	
7B90.0096	96	168	24	10	200
7B90.0128	128	200	24	10	200
7B90.0160	160	232	24	10	200
7B90.0224	224	296	24	10	200
7B90.0448	448	520	24	10	100

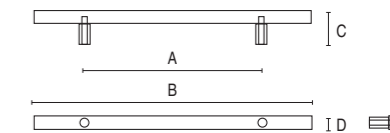

7B79 Ref.	A	B	C	D	
7B79.0104	64	104	16	7,5	200
7B79.0200	128	200	16	7,5	200
7B79.0400	160-160	400	16	7,5	200
7B79.0600	224-224	600	16	7,5	100
7B79.0800	320-320	800	16	7,5	100

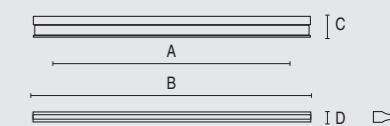

7067 Ref.	A	B	C	D	
7067.0072	32	72	19	8	200
7067.0104	64	104	19	8	200
7067.0200	64	200	19	8	200
7067.0300	128	300	19	8	200
7067.0400	192	400	19	8	200

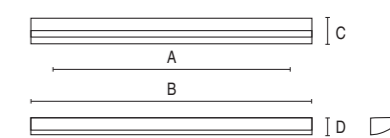



7290	Ref.	A	B	C	D	
	7290.0050	32	50	20	38	200
	7290.0200	128	200	20	38	200
	7290.0400	320	400	20	38	200

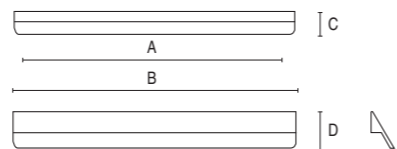

ALBORA



7295	Ref.	A	B	C	D	
	7295.0050	160	220	22	18	200
	7295.0200	320	400	22	18	200
	7295.0400	320	600	22	18	200

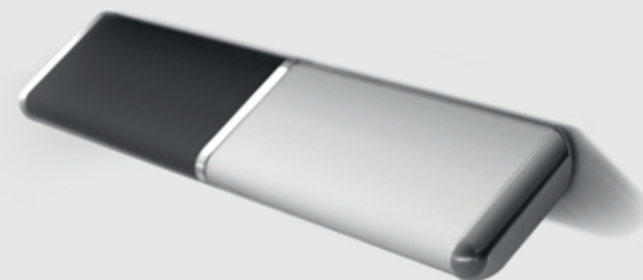
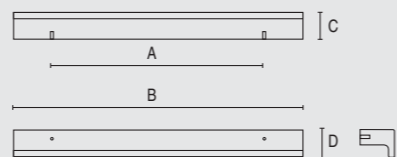

7242	Ref.	A	B	C	D	
	7242.0188	96	230	35	12	200
	7242.0238	128	280	35	12	200
	7242.0380	96-96-96	402	35	12	200

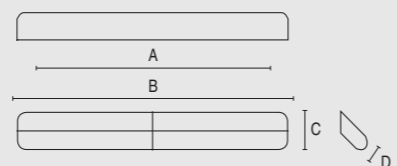

7694	Ref.	A	B	C	D	
	7694.0096	96	168	20	10	200
	7694.0128	128	200	20	10	200
	7694.0160	160	232	20	10	200
	7694.0224	224	296	20	10	200

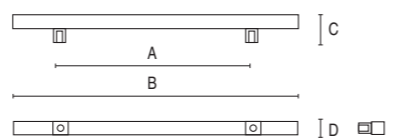

NA
 NAVARRO
 AZORIN

**EDGE
 ALUMINIUM**

NASS

7375	Ref.	A	B	C	D	E	F	
	7375.0137	96	137	39	16	17	20	25
	7375.0247	96-96	247	39	16	17	20	20
	7375.0297	128-128	297	39	16	17	20	20
	7375.0347	96-96-96	347	39	16	17	20	20
	7375.0397	96-96-96	397	39	16	17	20	20
	7375.0447	96-96-96	447	39	16	17	20	20
	7375.0497	128-128-128	497	39	16	17	20	20
	7375.0597	160-160-160	597	39	16	17	20	15
	7375.0697	192-192-192	697	39	16	17	20	15
	7375.0797	224-224-224	797	39	16	17	20	5
	7375.0897	256-256-256	897	39	16	17	20	5
	7375.0997	224-224-224-224	997	39	16	17	20	5

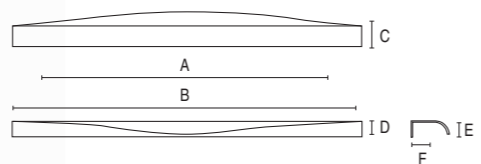

7215	Ref.	A	B	C	D	E	F	
	7215.0136	64	136	35	9	17	30	200
	7215.0150	64	150	35	9	17	30	200
	7215.0250	128	250	35	9	17	30	200
	7215.0300	128	300	35	9	17	30	200
	7215.0600	192	600	35	9	17	30	100

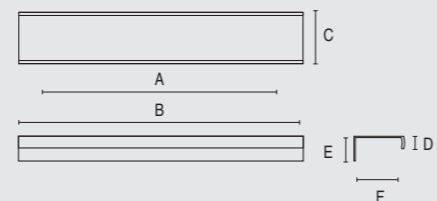

SAMAR

7382	Ref.	A	B	C	D	E	F	
	7382.0050	32	50	52,5	3	17	48	200
	7382.0200	128	200	52,5	3	17	48	200
	7382.0300	128	300	52,5	3	17	48	200
	7382.0400	192	400	52,5	3	17	48	200
	7382.0900	320-320	900	52,5	3	17	48	50

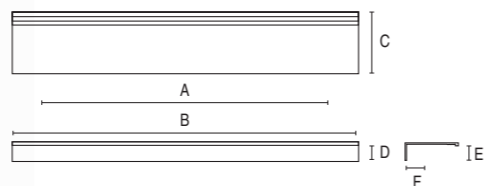

VOSGES

7326	Ref.	A	B	C	D	E	F	
	7326.0104	64	104	40	9	17	35	200
	7326.0168	64	168	40	9	17	35	200
	7326.0200	160	200	40	9	17	35	200
	7326.0400	192	400	40	9	17	35	200

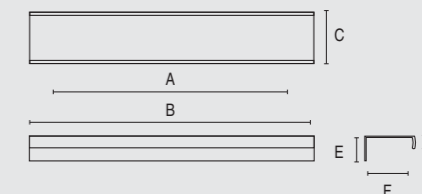

7341	Ref.	A	B	C	D	E	F	J	
	7341.0247	96-96	247	35	9	17	19	40	20
	7341.0297	128-128	297	35	9	17	19	40	20
	7341.0347	96-96-96	347	35	9	17	19	40	20
	7341.0397	96-96-96	397	35	9	17	19	40	20
	7341.0447	96-96-96	447	35	9	17	19	40	20
	7341.0497	128-128-128	497	35	9	17	19	40	20
	7341.0597	160-160-160	597	35	9	17	19	40	15
	7341.0697	192-192-192	697	35	9	17	19	40	15
	7341.0797	224-224-224	797	35	9	17	19	40	5
	7341.0897	256-256-256	897	35	9	17	19	40	5
	7341.0997	224-224-224-224	997	35	9	17	19	40	5

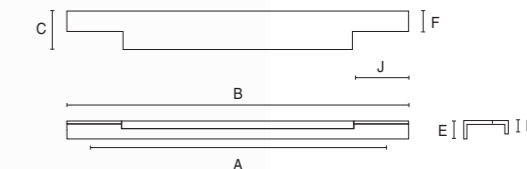

7030	Ref.	A	B	C	D	E	F	
	7030.0104	64	104	37	3	17	24	200
	7030.0200	64	200	37	3	17	24	200
	7030.0300	128	300	37	3	17	24	200
	7030.0400	192	400	37	3	17	24	200
	7030.0900	320-320	900	37	3	17	24	50

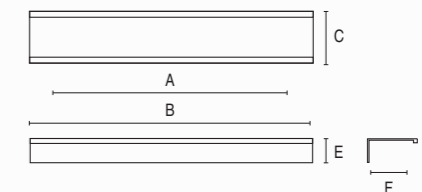

SAME

7384

Ref.	A	B	C	D	E	F	I	
7384.0247	96-96	247	24	12	14	19,7	32	10
7384.0297	128-128	297	24	12	14	19,7	32	10
7384.0347	96-96-96	347	24	12	14	19,7	32	10
7384.0397	96-96-96	397	24	12	14	19,7	32	10
7384.0447	96-96-96	447	24	12	14	19,7	32	10
7384.0497	128-128-128	497	24	12	14	19,7	32	10
7384.0597	160-160-160	597	24	12	14	19,7	32	5
7384.0697	192-192-192	697	24	12	14	19,7	32	5
7384.0797	224-224-224	797	24	12	14	19,7	32	5
7384.0897	256-256-256	897	24	12	14	19,7	32	5
7384.0997	224-224-224-224	997	24	12	14	19,7	32	5
7384.1197	224-224-224-224	1197	24	12	14	19,7	32	5
7384.3000	-	3000	24	12	14	19,7	32	25

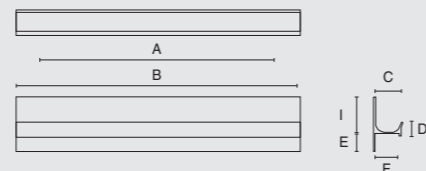

7328

Ref.	A	B	C	D	E	F	I	
7328.0150	64	150	35	6	17	20	200	
7328.0200	128	200	35	6	17	20	200	
7328.0300	128	300	35	6	17	20	200	
7328.0400	192	400	35	6	17	20	200	

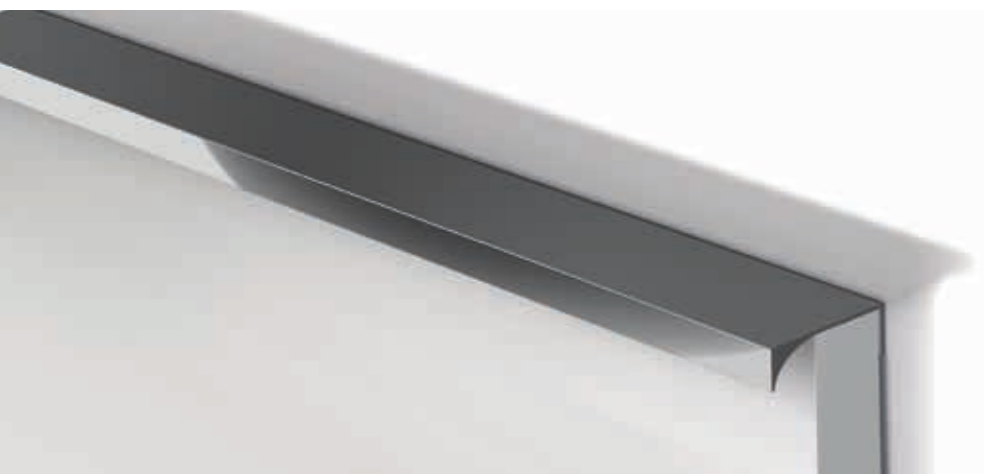
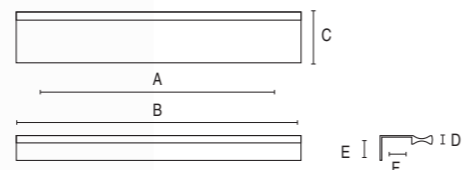

7364

Ref.	A	B	C	D	E	F	I	
7364.0300	192	300	39	12	17	20	200	
7364.0400	320	400	39	12	17	20	200	
7364.0500	320	500	39	12	17	20	200	
7364.0600	192-192	600	39	12	17	20	100	

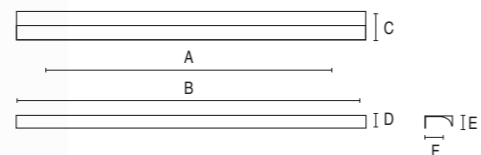

7363

Ref.	A	B	C	D	E	F	I	
7363.0137	96	137	39	12	17	20	25	
7363.0247	96-96	247	39	12	17	20	20	
7363.0297	128-128	297	39	12	17	20	20	
7363.0347	96-96-96	347	39	12	17	20	20	
7363.0397	96-96-96	397	39	12	17	20	20	
7363.0447	96-96-96	447	39	12	17	20	20	
7363.0497	128-128-128	497	39	12	17	20	20	
7363.0597	160-160-160	597	39	12	17	20	15	
7363.0697	192-192-192	697	39	12	17	20	15	
7363.0797	224-224-224	797	39	12	17	20	5	
7363.0897	256-256-256	897	39	12	17	20	5	
7363.0997	224-224-224-224	997	39	12	17	20	5	

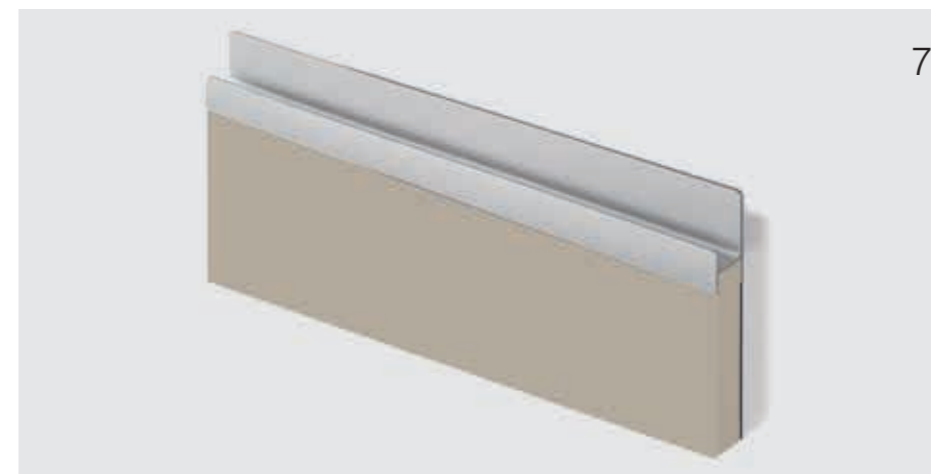
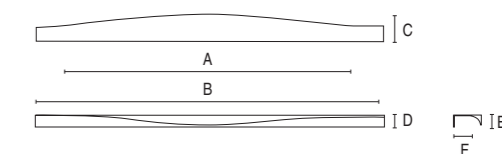

7344

Ref.	A	B	C	D	E	F	I	
7344.0200	160	200	23,5	24,5	15	20	38	200
7344.0300	192	300	23,5	24,5	15	20	38	200
7344.0400	320	400	23,5	24,5	15	20	38	200
7344.0500	192-192	500	23,5	24,5	15	20	38	200

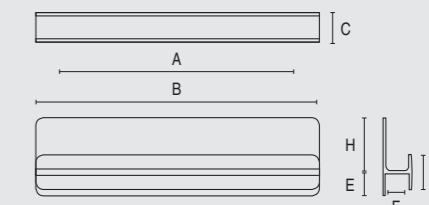

7289

Ref.	A	B	C	D	E	F	I	
7289.0298	192	298	19	12	14	17	32	200
7289.0400	192	400	19	12	14	17	32	200
7289.0457	192-192	457	19	12	14	17	32	200
7289.0597	224-224	597	19	12	14	17	32	100

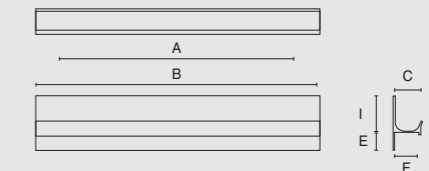



7362	Ref.	A	B	C	D	E	F	
	7362.0300	192	300	34	16	17	17	200
	7362.0400	320	400	34	16	17	17	100
	7362.0500	320	500	34	16	17	17	50
	7362.0600	192-192	600	34	16	17	17	50

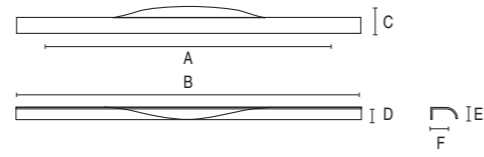

7020	Ref.	A	B	C	D	E	F	
	7020.0050	32	50	48	6	28	20	200
	7020.0200	64	200	48	6	28	20	200
	7020.0400	192	400	48	6	28	20	200
	7020.0900	320-320	900	48	6	28	20	50

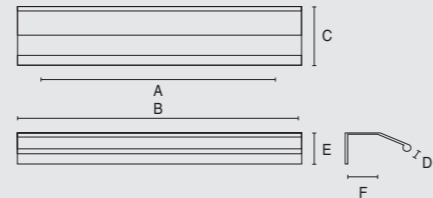

7031	Ref.	A	B	C	D	E	F	
	7031.0104	64	104	37	7	17	30	200
	7031.0200	64	200	37	7	17	30	200
	7031.0300	128	300	37	7	17	30	200
	7031.0600	192	600	37	7	17	30	100

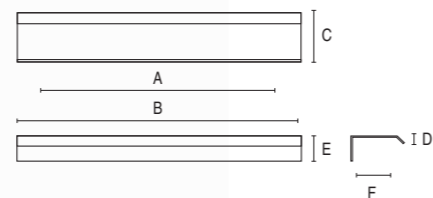

7396	Ref.	A	B	C	D	E	F	
	7396.0150	64	150	35	4	17	20	200
	7396.0200	128	200	35	4	17	20	200
	7396.0300	128	300	35	4	17	20	200
	7396.0400	192	400	35	4	17	20	200

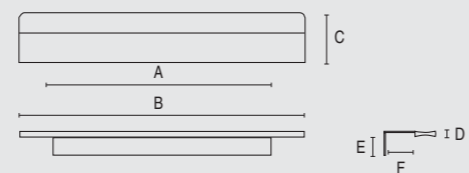

HARPOON ALUMINIUM

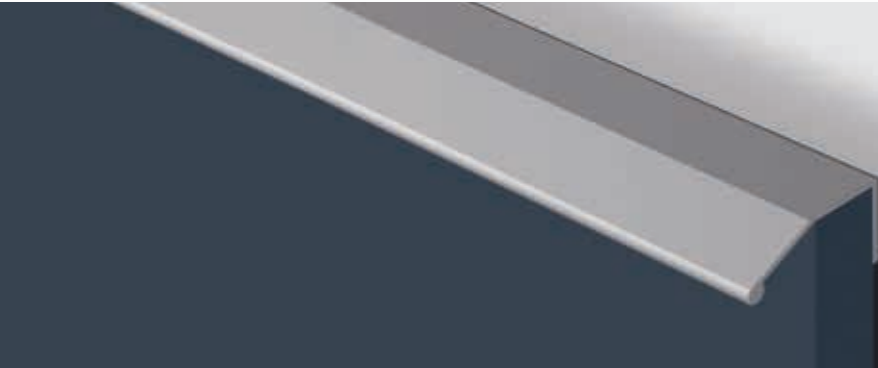



THOR

7390

Ref.	A	B	C	D	F	
7390.0247	207	247	16	16	16,5	20
7390.0297	257	297	16	16	16,5	20
7390.0347	307	347	16	16	16,5	20
7390.0397	357	397	16	16	16,5	20
7390.0447	407	447	16	16	16,5	20
7390.0497	457	497	16	16	16,5	20
7390.0597	557	597	16	16	16,5	15
7390.0697	657	697	16	16	16,5	15
7390.0797	757	797	16	16	16,5	5
7390.0897	857	897	16	16	16,5	5
7390.0997	957	997	16	16	16,5	5
7390.1197	1157	1197	16	16	16,5	5
7390.3000	—	3000	16	16	16,5	25

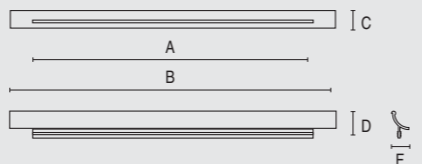
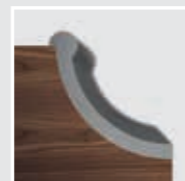

TIMMI

7389

Ref.	A	B	C	D	F	
7389.0247	207	247	17,7	1,5	15	20
7389.0297	257	297	17,7	1,5	15	20
7389.0347	307	347	17,7	1,5	15	20
7389.0397	357	397	17,7	1,5	15	20
7389.0447	407	447	17,7	1,5	15	20
7389.0497	457	497	17,7	1,5	15	20
7389.0597	557	597	17,7	1,5	15	15
7389.0697	657	697	17,7	1,5	15	15
7389.0797	757	797	17,7	1,5	15	5
7389.0897	857	897	17,7	1,5	15	5
7389.0997	957	997	17,7	1,5	15	5
7389.1197	1157	1197	17,7	1,5	15	5
7389.3000	—	3000	17,7	1,5	15	25

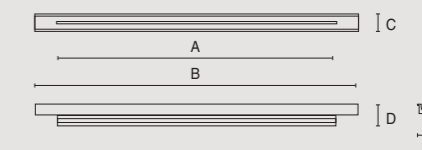

TUI

7393

Ref.	A	B	C	D	F	
7393.0247	207	247	19,5	1,7	16,5	20
7393.0297	257	297	19,5	1,7	16,5	20
7393.0347	307	347	19,5	1,7	16,5	20
7393.0397	357	397	19,5	1,7	16,5	20
7393.0447	407	447	19,5	1,7	16,5	20
7393.0497	457	497	19,5	1,7	16,5	20
7393.0597	557	597	19,5	1,7	16,5	15
7393.0697	657	697	19,5	1,7	16,5	15
7393.0797	757	797	19,5	1,7	16,5	5
7393.0897	857	897	19,5	1,7	16,5	5
7393.0997	957	997	19,5	1,7	16,5	5
7393.1197	1157	1197	19,5	1,7	16,5	5
7393.3000	—	3000	19,5	1,7	16,5	25

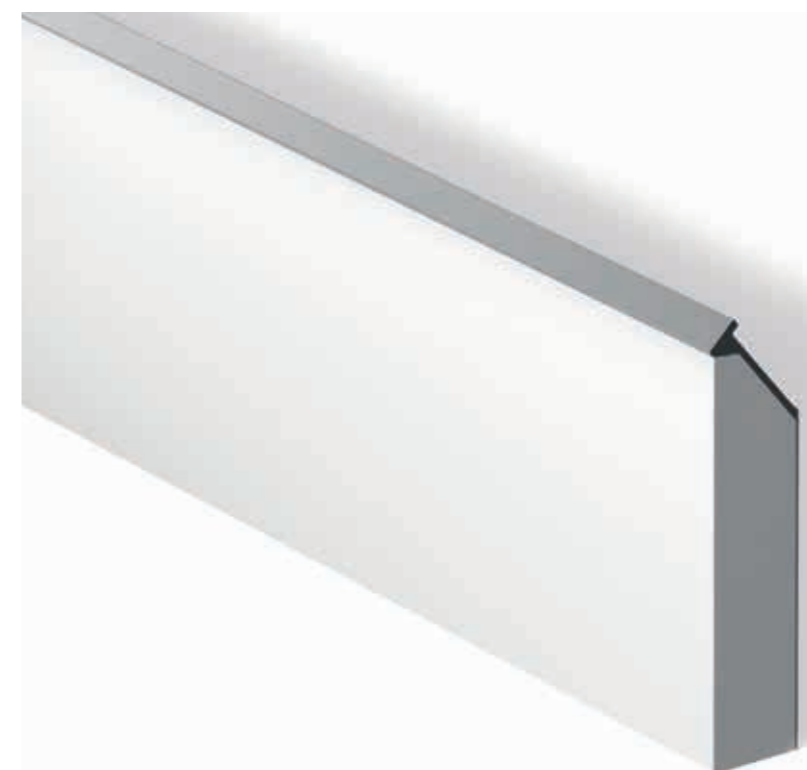
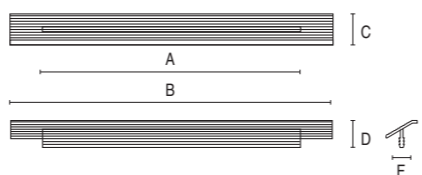
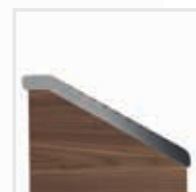

7366

Ref.	A	B	C	D	F	
7366.0462	412	462	16,5	7	16	200
7366.0562	512	562	16,5	7	16	100
7366.0762	712	762	16,5	7	16	100

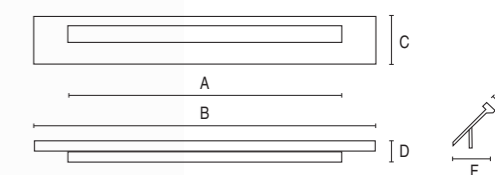

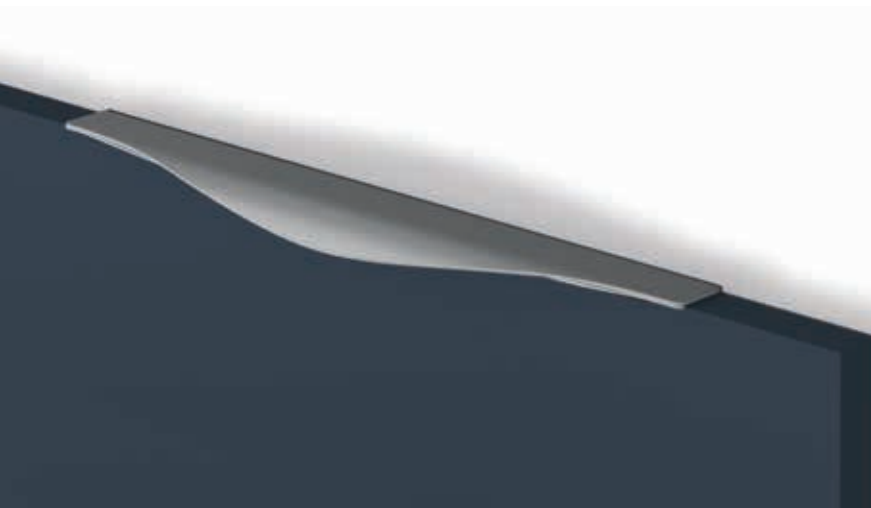

7329

Ref.	A	B	C	D	F	
7329.0247	197	247	35	15	17	20
7329.0297	247	297	35	15	17	20
7329.0347	297	347	35	15	17	20
7329.0397	347	397	35	15	17	20
7329.0447	397	447	35	15	17	20
7329.0497	447	497	35	15	17	20
7329.0597	547	597	35	15	17	15
7329.0697	647	697	35	15	17	15
7329.0797	747	797	35	15	17	5
7329.0897	847	897	35	15	17	5
7329.0997	947	997	35	15	17	5
7329.1197	1147	1197	35	15	17	5

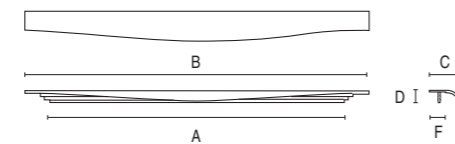

7327

Ref.	A	B	C	D	F	
7327.0247	207	247	28	6	20	20
7327.0297	257	297	28	6	20	20
7327.0347	307	347	28	6	20	20
7327.0397	357	397	28	6	20	20
7327.0447	407	447	28	6	20	20
7327.0497	457	497	28	6	20	20
7327.0597	557	597	28	6	20	15
7327.0697	657	697	28	6	20	15
7327.0797	757	797	28	6	20	5
7327.0897	857	897	28	6	20	5
7327.0997	957	997	28	6	20	5
7327.1197	1157	1197	28	6	20	5
7327.3000	-	3000	28	6	20	25

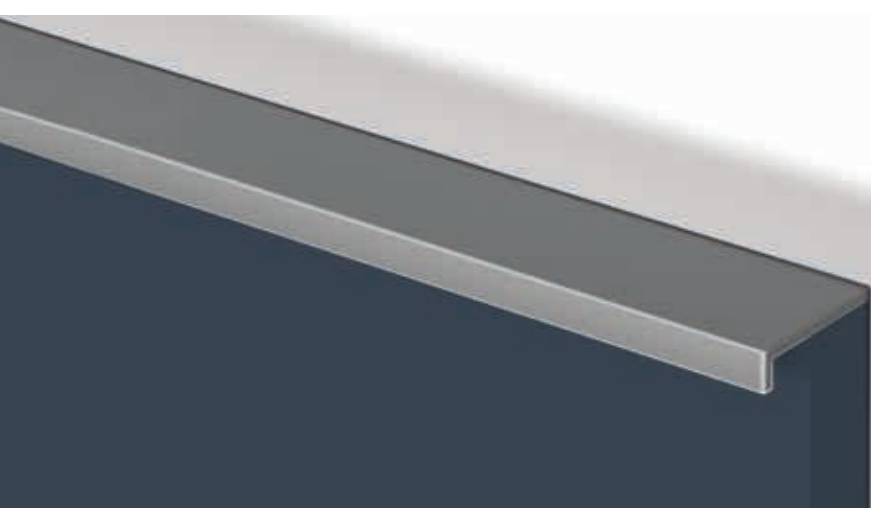
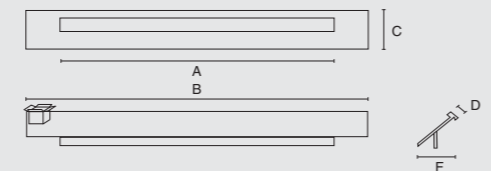

7235

Ref.	A	B	C	D	F	
7235.0247	207	247	36	10	33	20
7235.0297	257	297	36	10	33	20
7235.0347	307	347	36	10	33	20
7235.0397	357	397	36	10	33	20
7235.0447	407	447	36	10	33	20
7235.0497	457	497	36	10	33	20
7235.0597	557	597	36	10	33	15
7235.0697	657	697	36	10	33	15
7235.0797	757	797	36	10	33	5
7235.0897	857	897	36	10	33	5
7235.0997	957	997	36	10	33	5
7235.1197	1157	1197	36	10	33	5

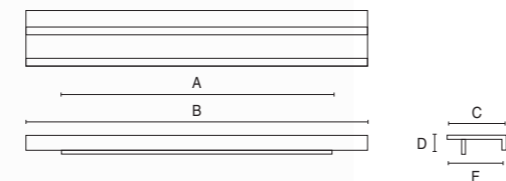

7212

Ref.	A	B	C	D	F	J	
7212.0247	207	247	36	10	20	50	20
7212.0297	257	297	36	10	20	50	20
7212.0347	307	347	36	10	20	50	20
7212.0397	357	397	36	10	20	50	20
7212.0447	407	447	36	10	20	50	20
7212.0497	457	497	36	10	20	50	20
7212.0597	557	597	36	10	20	50	15
7212.0697	657	697	36	10	20	50	15
7212.0797	757	797	36	10	20	50	5
7212.0897	857	897	36	10	20	50	5
7212.0997	957	997	36	10	20	50	5
7212.1197	1157	1197	36	10	20	50	5

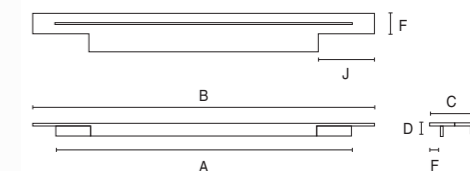

7170

Ref.	A	B	C	D	F	I	
7170.0247	207	247	21	32	19	30	10
7170.0297	257	297	21	32	19	30	10
7170.0347	307	347	21	32	19	30	10
7170.0397	357	397	21	32	19	30	10
7170.0447	407	447	21	32	19	30	10
7170.0497	457	497	21	32	19	30	10
7170.0597	557	597	21	32	19	30	5
7170.0697	657	697	21	32	19	30	5
7170.0797	757	797	21	32	19	30	5
7170.0897	857	897	21	32	19	30	5
7170.0997	957	997	21	32	19	30	5
7170.1197	1157	1197	21	32	19	30	5
7170.3000	-	3000	21	32	19	30	25

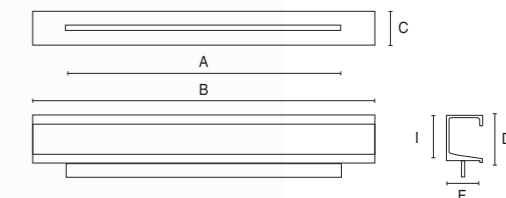

WAVE



7316

Ref.	A	B	C	D	F	
7316.0247	197	247	38	15	20	20
7316.0297	247	297	38	15	20	20
7316.0347	297	347	38	15	20	20
7316.0397	347	397	38	15	20	20
7316.0447	397	447	38	15	20	20
7316.0497	447	497	38	15	20	20
7316.0597	547	597	38	15	20	15
7316.0697	647	697	38	15	20	15
7316.0797	747	797	38	15	20	5
7316.0897	847	897	38	15	20	5
7316.0997	947	997	38	15	20	5
7316.1197	1147	1197	38	15	20	5

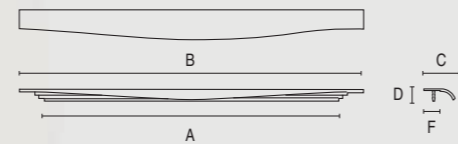

NA NAVARRO AZORÍN

TURIA



7193

Ref.	A	B	C	D	
7193.0290	250	290	7	5	200
7193.0390	350	390	7	5	200
7193.0560	520	560	7	5	100

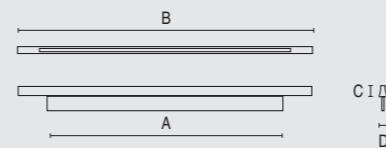

DESIGN Z

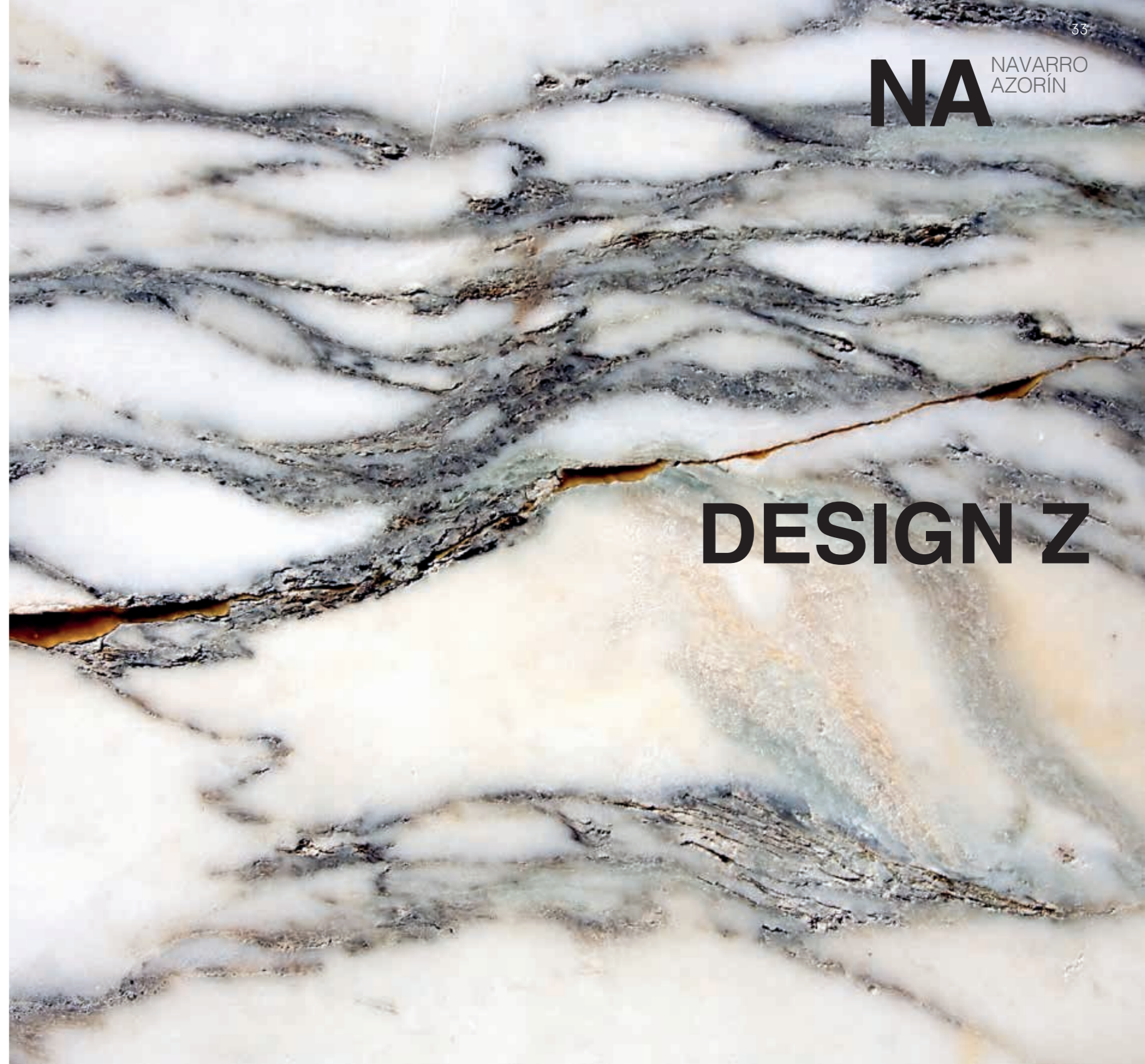

SNICE

7394

Ref.	A	B	C	D
7394.0160	160	236	28	8

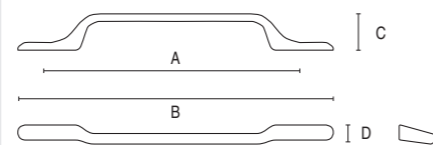

7021

Ref.	A	B	C	D
7021.0032	32	50	30	13
7021.0160	160	172	30	13
7021.0192	192	204	30	13

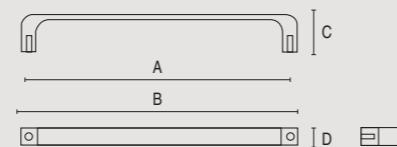
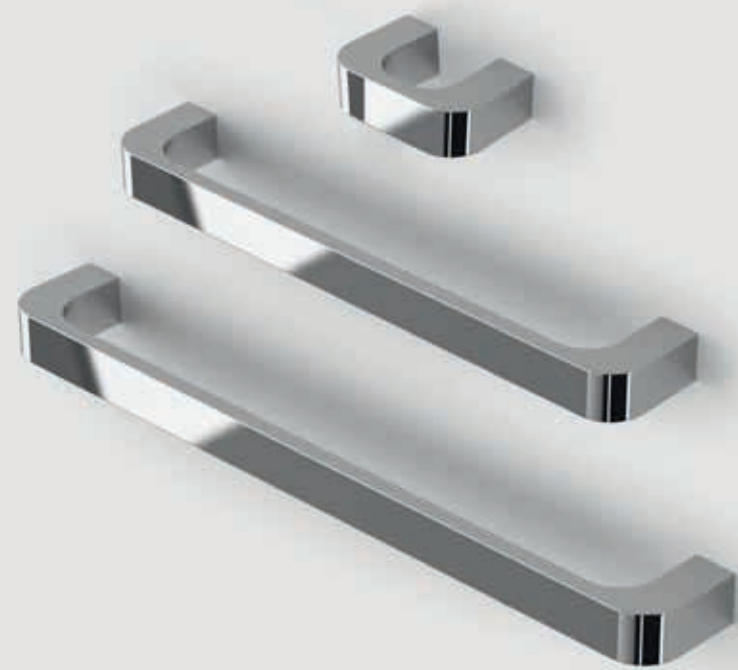

7371

Ref.	A	B	C	D
7371.0128	128	157,6	28	6,3
7371.0192	192	221,6	28	6,3
7371.0320	320	349,6	28	6,3

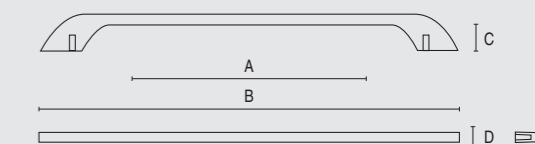
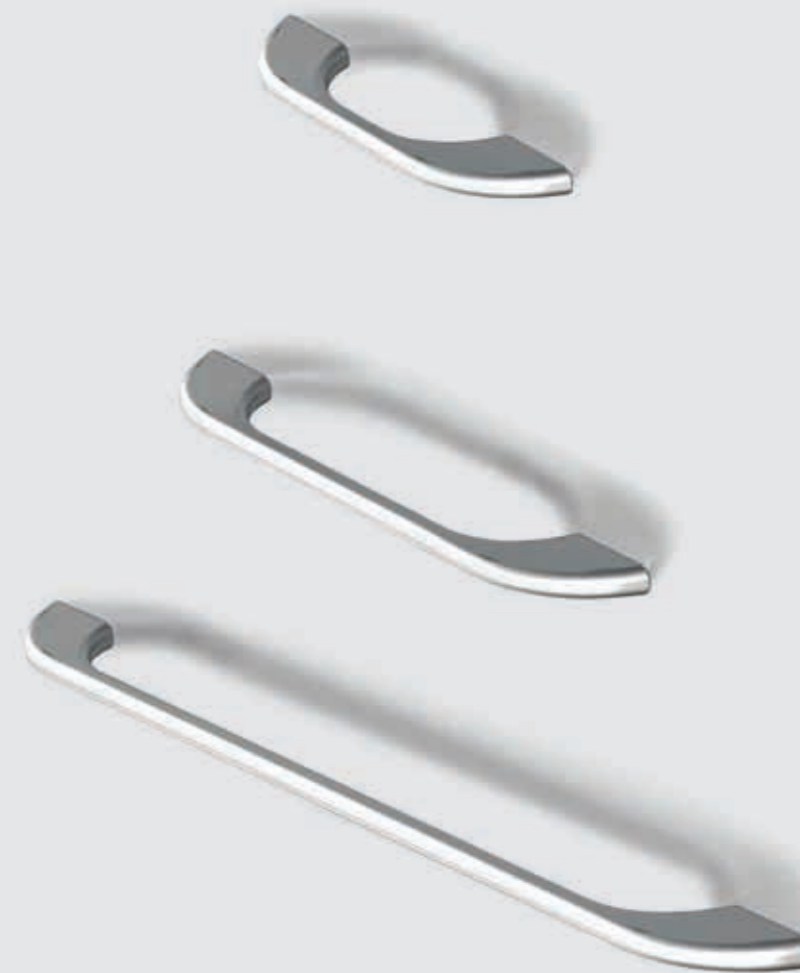

7323

Ref.	A	B	C	D
7323.0160	160	172	22	18

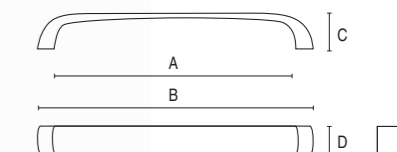

MIKE

7374

Ref.	A	B	C	D
7374.0128	128	137	25	22
7374.0192	192	205	24	21

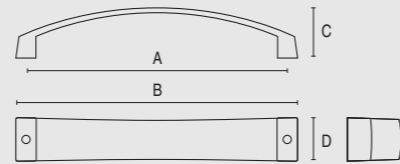

7742

Ref.	A	B	C	D
7742.0064	64	77	18	8
7742.0096	96	109	18	8

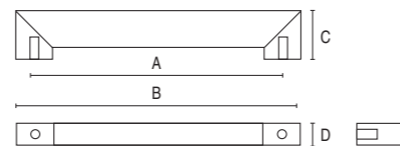
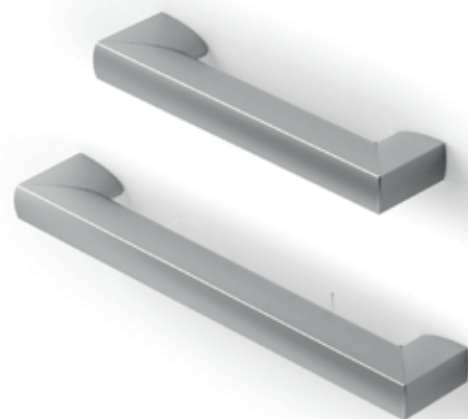

7250

Ref.	A	B	C	D
7250.0128	128	190	42	8
7250.0192	192	254	42	8
7250.0256	256	318	42	8

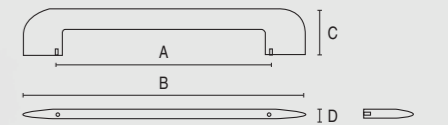

7330

Ref.	A	B	C	D
7330.0160	160	200	25	22

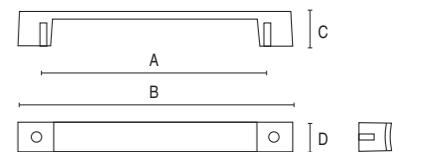

ELBE

7321

Ref.	A	B	C	D
7321.0200	64	200	24	12
7321.0300	128	300	26	12
7321.0400	160-288	400	27	12

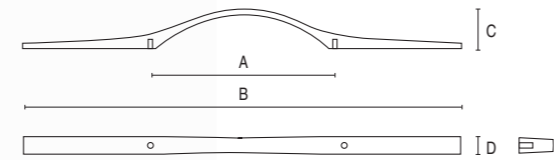

7720

Ref.	A	B	C	D
7720.0128	128	155	24	20

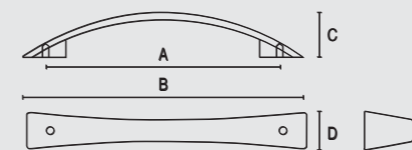

7342

Ref.	A	B	C	D
7342.0128	128	190	20	22

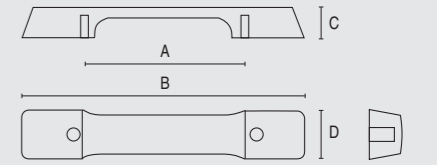

7003

Ref.	A	B	C	D
7003.0096	96	103	21	10
7003.0128	128	135	21	10
7003.0288	288	300	25	10

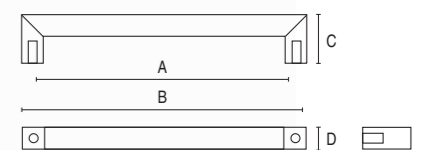

CITY



7391

Ref.	A	B	C	D
7391.0128	128	180	20	22
7391.0192	192	244	25	22

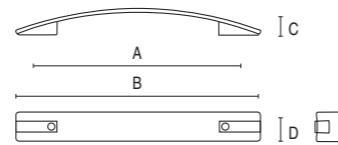

7004

Ref.	A	B	C	D
7004.0064	64	76	17	12
7004.0096	96	108	17	12
7004.0128	128	140	17	12

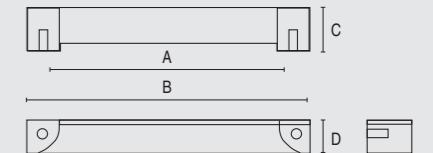
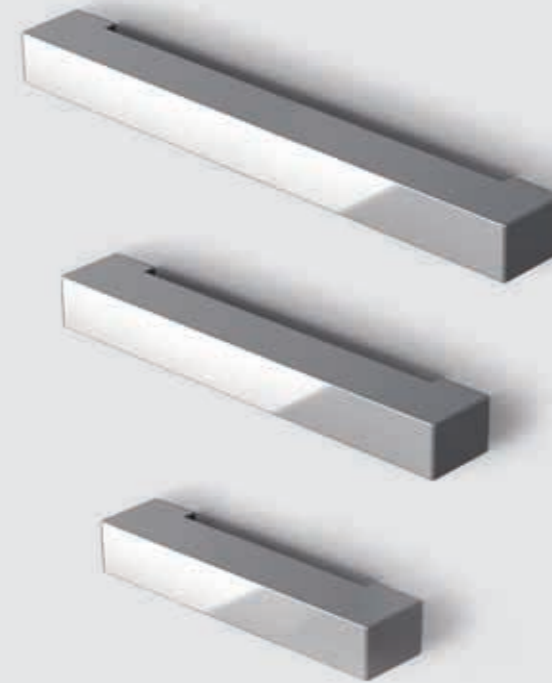

CHARENTE



7299

Ref.	A	B	C	D
7299.0078	64	78	16	40

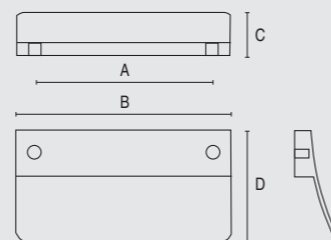

7111

Ref.	A	B	C	D
7111.0032	32	70	15	20
7111.0064	64	110	14	20
7111.0096	96	130	24	20

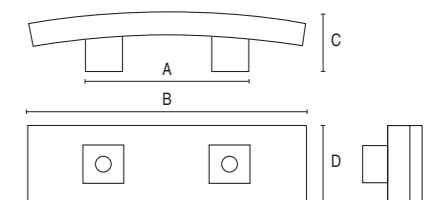
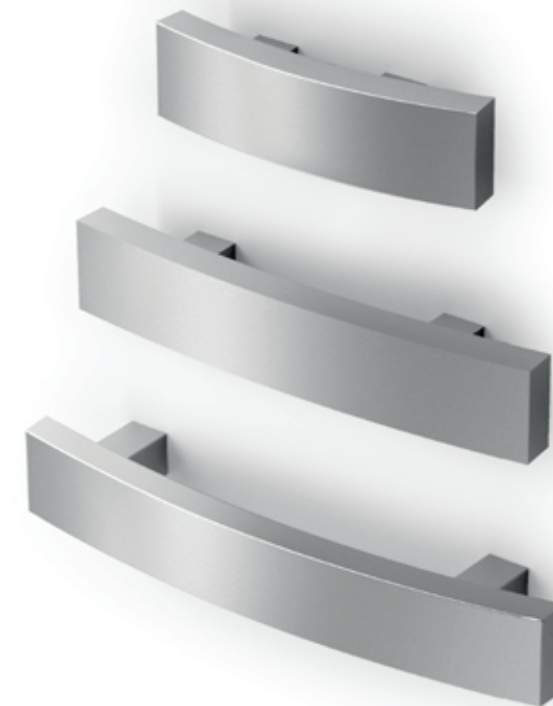

7269

Ref.	A	B	C	D
7269.0032	32	125	18	50

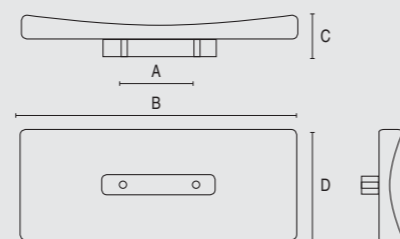

RHONE



7298

Ref.	A	B	C	D
7298.0128	128	142	23	14
7298.0192	192	207	23	14,5

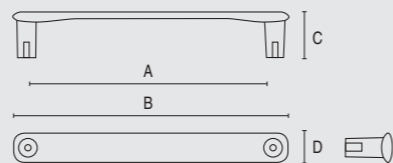

MEUSE



7232

Ref.	A	B	C	D
7232.0064	64	80	19	39
7232.0128	128	148	19	39

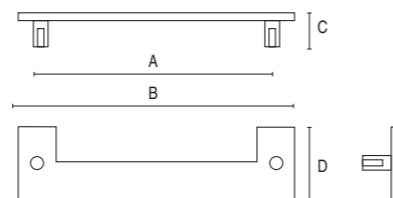

7001

Ref.	A	B	C	D
7001.0032	32	44	15	10
7001.0064	64	76	17	10
7001.0096	96	108	19	10
7001.0160	160	172	21	10

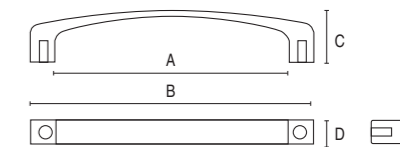
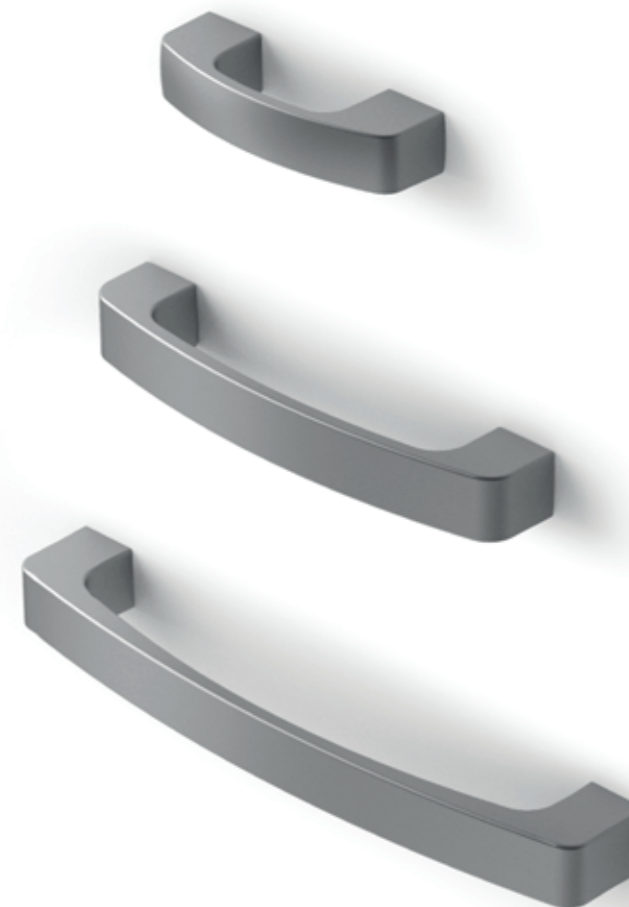

7276

Ref.	A	B	C	D
7276.0064	64	105	19	22

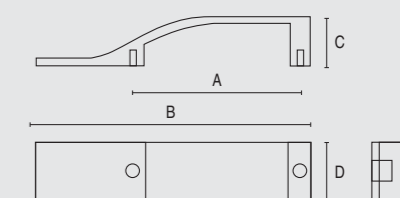

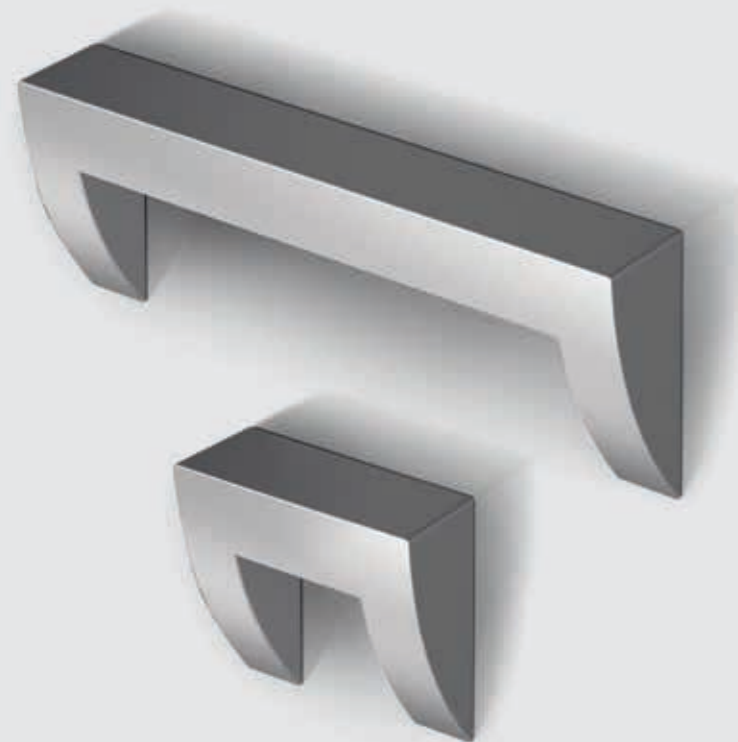

7006

Ref.	A	B	C	D
7006.0032	32	40	14	40
7006.0096	96	104	14	40

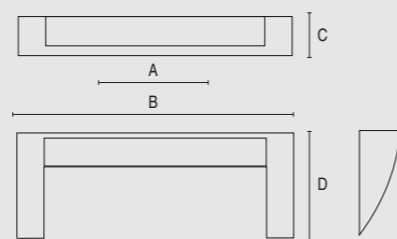

7579

Ref.	A	B	C	D
7579.0022	-	22	20	14
7579.0055	32	55	20	14
7579.0080	64	80	20	14

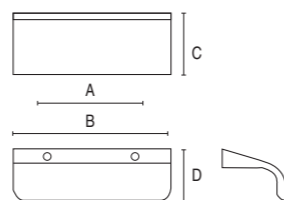

7254

Ref.	A	B	C	D
7254.0032	32	80	18	23

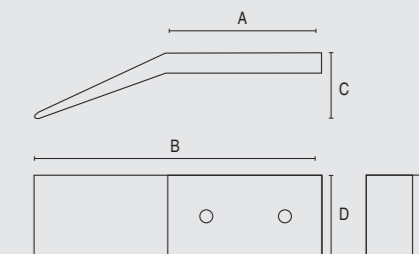
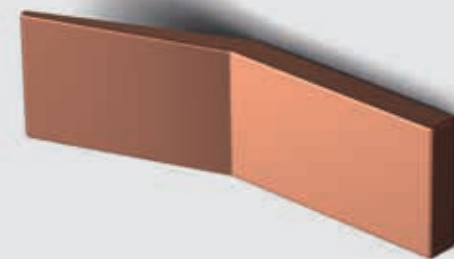

7271

Ref.	A	B	C	D
7271.0032	32	80	17	68

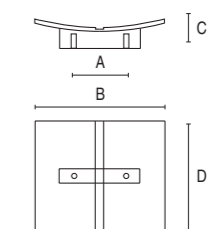

7292

Ref.	A	B	C	D
7292.0032	32	100	19	60

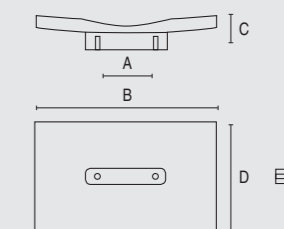

OVUM



7381

Ref.	A	B	C	D	F
7381.0128	128	148	22	48	15

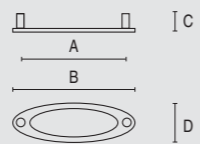

REIHN

7319

Ref.	A	B	C	D
7319.0125	96	125	20	32
7319.0200	128	200	20	32

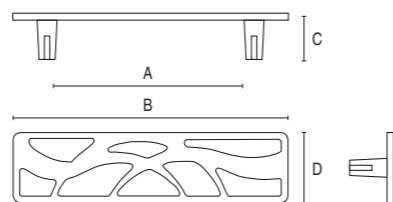

DORDOGNE



7180

Ref.	A	B	C	D
7180.0064	64	116	13	47

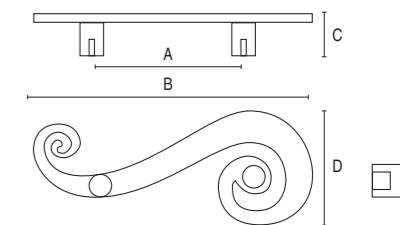

7181

Ref.	A	B	C	D
7181.0064	64	116	13	47

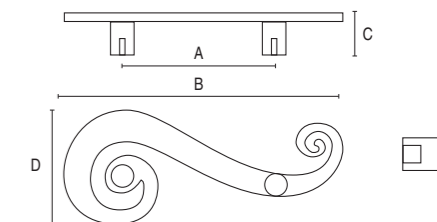

LOIRE

7224

Ref.	A	B	C	D
7224.0140	128	140	18	41
7224.0180	64	180	20	47

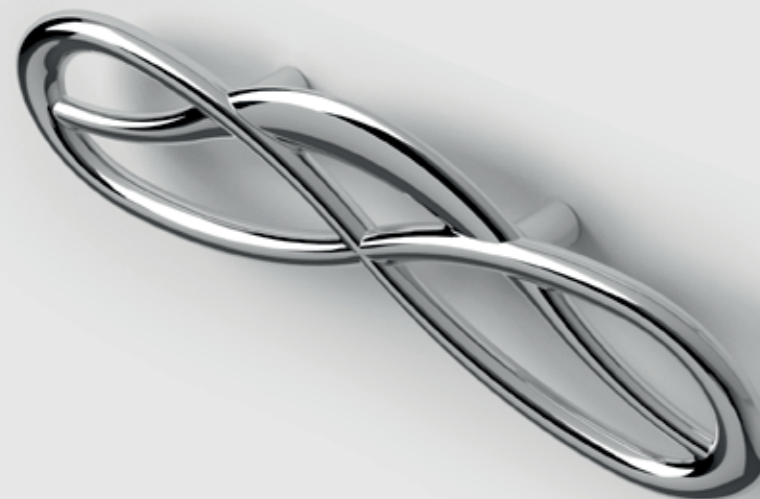
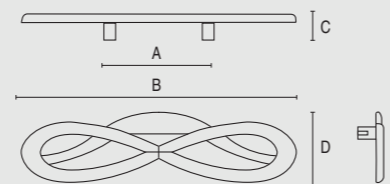

NA NAVARRO
AZORÍN

KNOBS

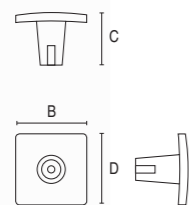
1037	Ref.	A	B	C	D
	1037.0032	-	32	23	32

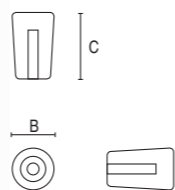

1040	Ref.	A	B	C
	1040.0015	-	15	24



CARRE

1003	Ref.	A	B	C
	1003.0025	-	25	16
	1003.0040	-	40	17
	1003.0050	16	50	18
	1003.0060	16	60	20

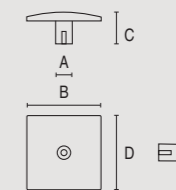
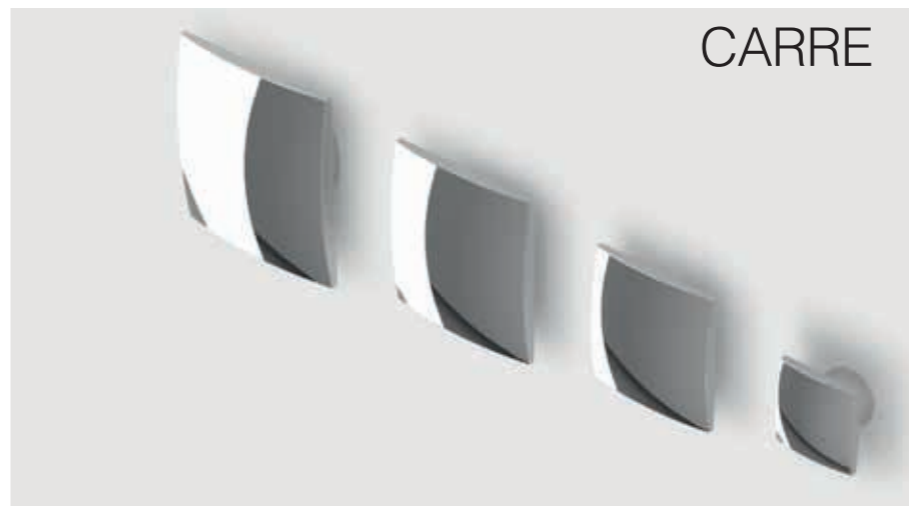

1038	Ref.	A	B	C
	1038.0040	-	40	14

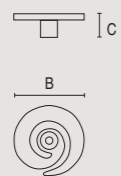

DONAU

1041	Ref.	A	B	C	D
	1041.0067	32	67	20	67

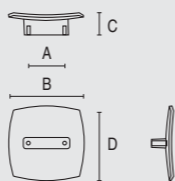

1105	Ref.	A	B	C	D
	1105.0030	-	30	20	30

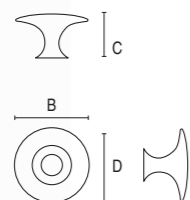

1043	Ref.	A	B	C	D
	1043.0047	-	47	17	47

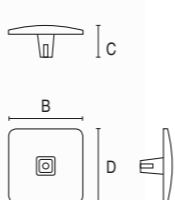

1116	Ref.	A	B	C
	1116.0020	-	20	26
	1116.0025	-	25	33
	1116.0030	-	30	40

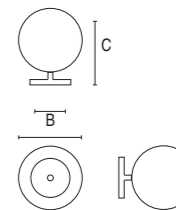

1784	Ref.	A	B	C	D
	1784.0016	-	16	13	14

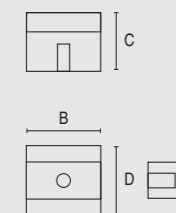
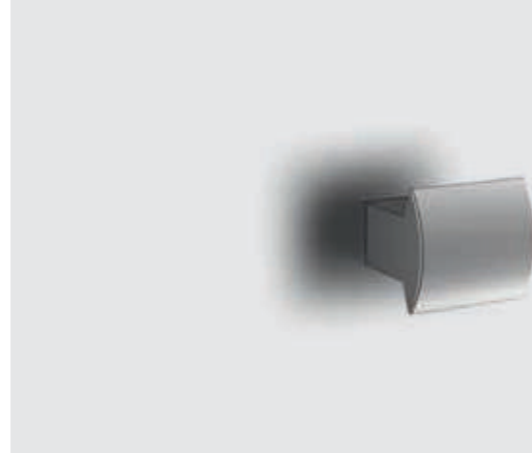

1468 Ref. A B C
1468.0016 - 16 21

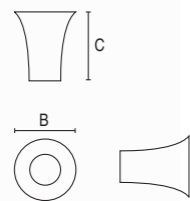

1798 Ref. A B C
1798.0015 - 15 18

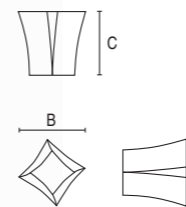

1031 Ref. A B C D
1031.0040 - 40 13 -

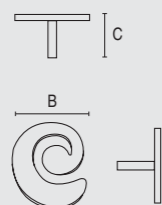

NASS



1017 Ref. A B C D
1017.0034 - 34 21 28

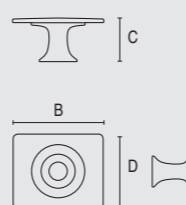

1036 Ref. A B C D
1036.0060 - 60 21 60

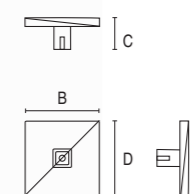

1023 Ref. A B C
1023.0048 - 48 27

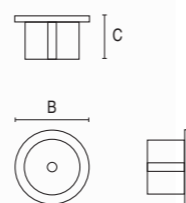

1324 Ref. A B C
1324.0025 - 25 19
1324.0030 - 30 23

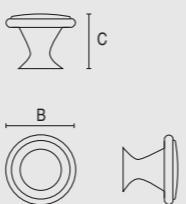
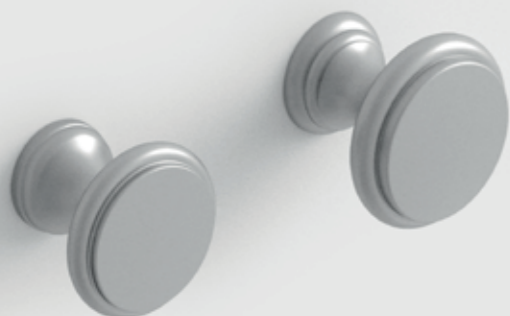

NA NAVARRO
AZORÍN

RECESSED

TAY



3029	Ref.	A	B	C	D	G
	3029.0200	128	200	21	35	16,8

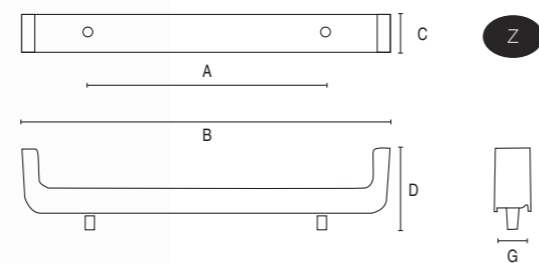

TOME



7370	Ref.	A	B	C	D	F
	7370.0218	220	180	23,4	35	20
	7370.0380	380	340	23,4	35	20
	7370.0500	500	460	23,4	35	20

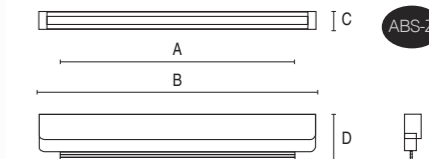

DAIDO



7397	Ref.	A	B	C	D	E	G
	7397.0190	32	190	15	48	42	12

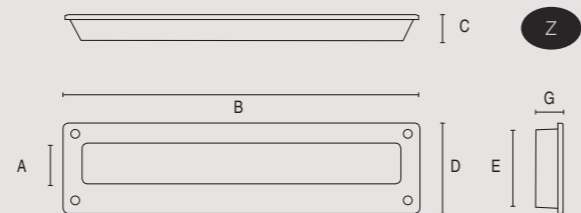

7365	Ref.	A	B	C	D	E	F
	7365.0160	160	171	12	45	41	10,5

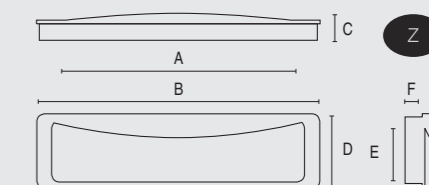

ATLANTA



7399	Ref.	A	B	C	D	E	G
	7399.0190	32	190	15	48	42	12

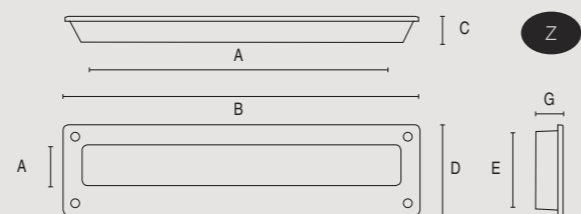

CUNA



3013	Ref.	A	B	C	G
	3013.0104	-	100	-	18

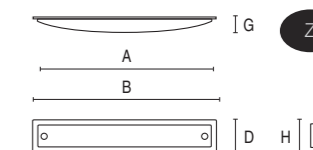



RAY

3028

Ref.	A	B	C	D	G
3028.0220	128	220	21	35	19,8

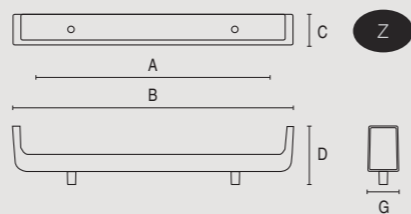

3021

Ref.	A	B	C	D	G
3021.0100	97	100	16	18	11
3021.0180	177	180	16	18	11

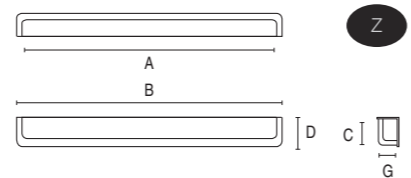

3A56

Ref.	A	B	D	G	H
3A56.0150	140	150	35	11	32

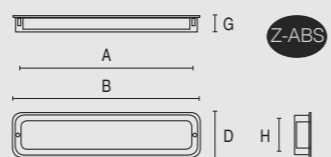

7744

Ref.	A	B	C	D	E	G
7744.0106	64	106	16	25	21	10

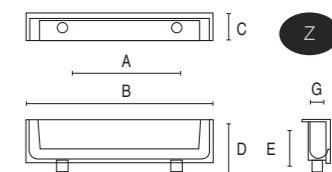

3775

Ref.	A	B	C	D	E	G
3775.0032	32	44	13	44	33	8

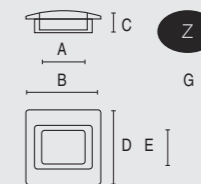

7248

Ref.	A	B	C	D	E	G
7248.0096	96	106	13	40	35	13
7248.0128	128	138	13	40	35	13
7248.0160	160	170	13	40	35	13
7248.0320	320	330	13	40	35	13

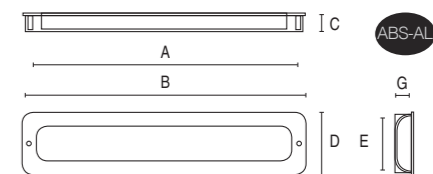

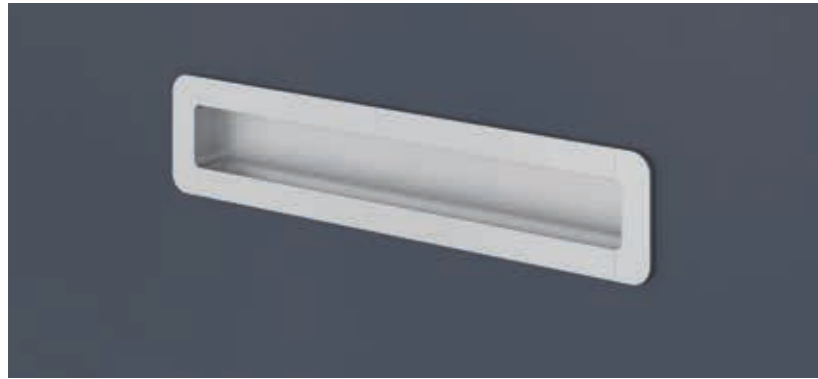

7234	Ref.	A	B	C	D	E	G
	7234.0128	128	139	15	50	45	13
	7234.0192	192	203	15	50	45	13
	7234.0256	256	267	15	50	45	13
	7234.0576	576	587	15	50	45	13

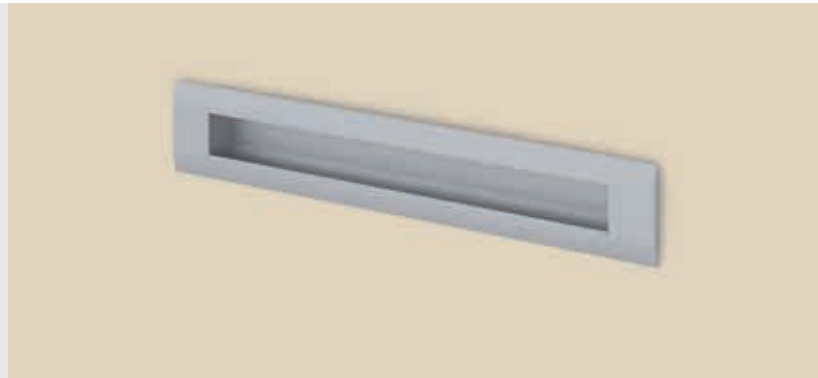
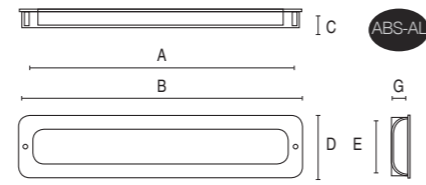

7061	Ref.	A	B	C	D	E	G
	7061.0096	96	108	15	40	35	12
	7061.0128	128	140	15	40	35	12
	7061.0192	192	204	15	40	35	12

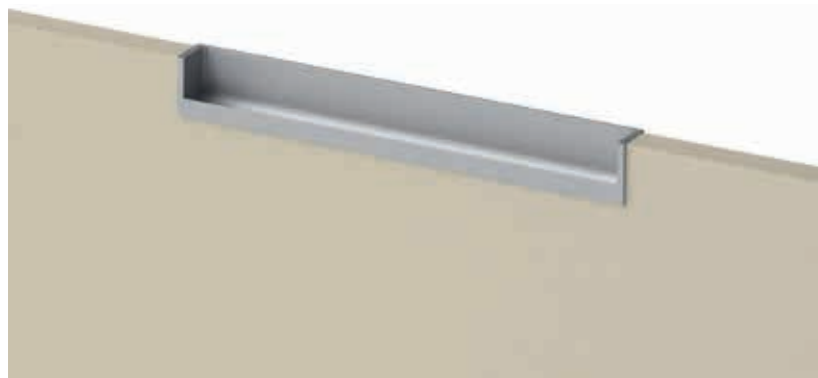
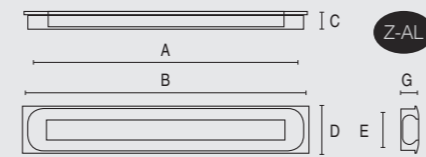

7334	Ref.	A	B	C	D	E	F
	7334.0199	160	207	19,5	51	39	22
	7334.0279	160	287	19,5	51	39	22
	7334.0492	320	500	19,5	51	39	22
	7334.0792	320-320	800	19,5	51	39	22

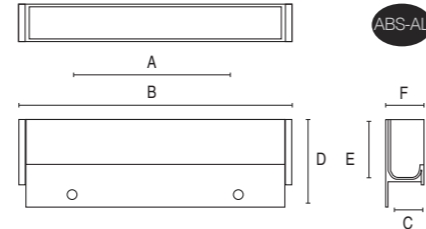

K301	Ref.	A	B	C	G
	K301.0040	35	40	10	8

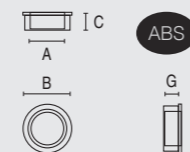

3020	Ref.	A	B	C	G
	3020.0040	35	40	16	12

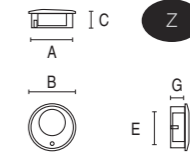

3022	Ref.	A	B	C	D	E	G
	3022.0165	128	165	15	50	45	13

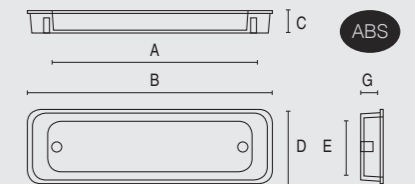

3026	Ref.	A	B	C	D	G
	3026.0128	128	145	22	58	12,5

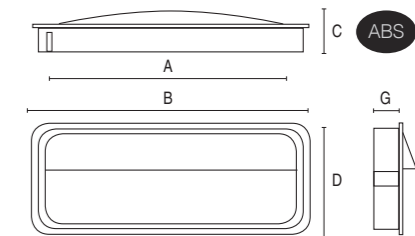



3023	Ref.	A	B	C	D	E	G
	3023.0060	37	60	15	60	56	13

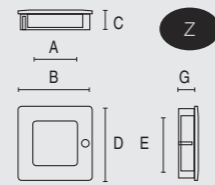

TOYA

3027	Ref.	A	B	C	G
	3027.0090	84,5	90	14	12

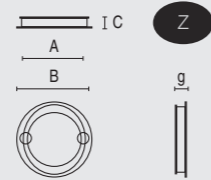

7297	Ref.	A	B	C	D
	7297.0060	32	60	5	7

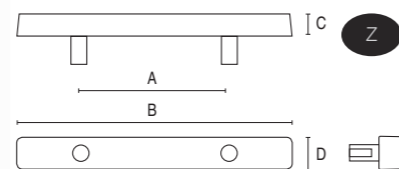

NA NAVARRO
AZORÍN

ABS



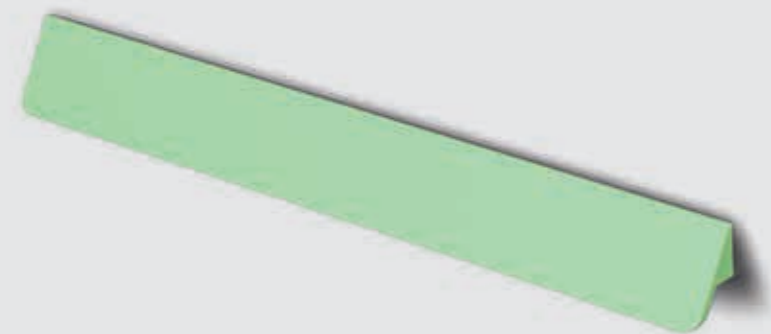

7291	Ref.	A	B	C	D
	7291.0250	128	250	16	26

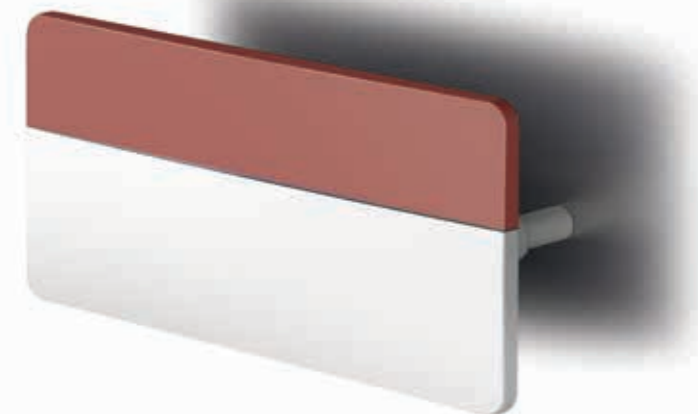
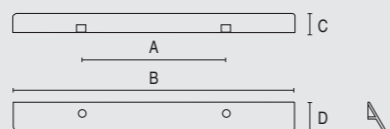

7236	Ref.	A	B	C	D
	7236.0128	128	160	23	73

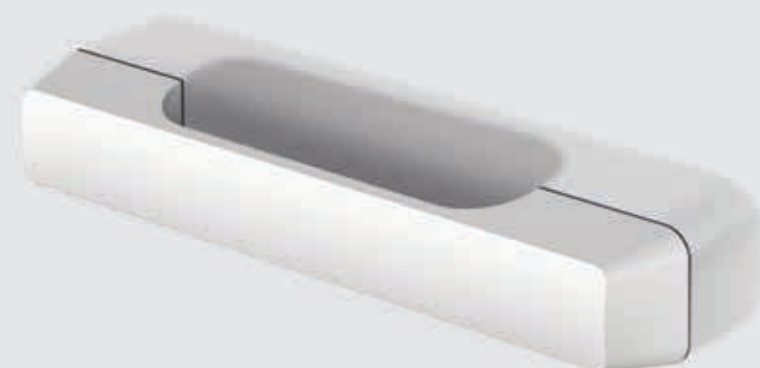
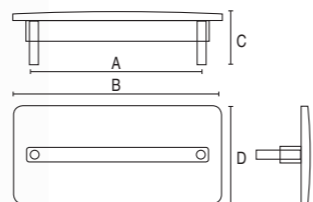

7339	Ref.	A	B	C	D
	7339.0128	128	211	23	35,5

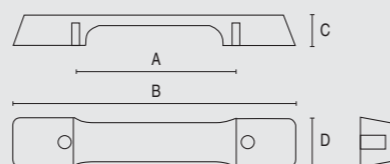

7B63	Ref.	A	B	C	D
	7B63.0128	128	200	25	40

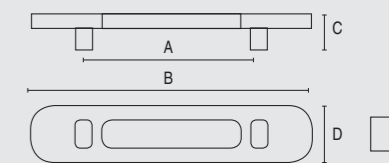

7091	Ref.	A	B	C	D
	7091.0128	128	138	24	21

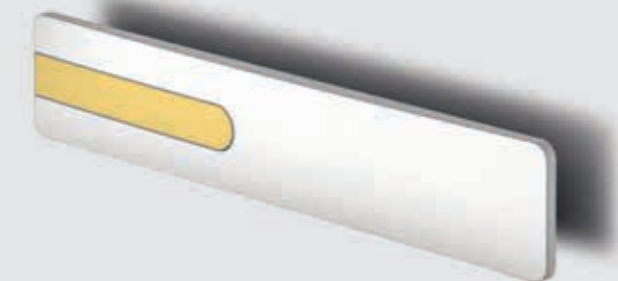
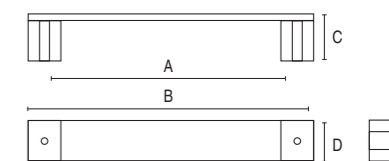

7196	Ref.	A	B	C	D
	7196.0128	128	210	20	40

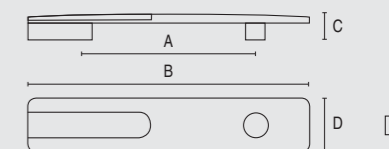

K716	Ref.	A	B	C	D
	K716.0220	128-160	220	20	25

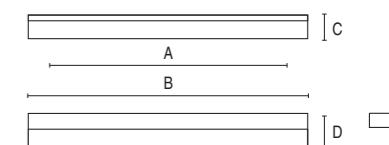

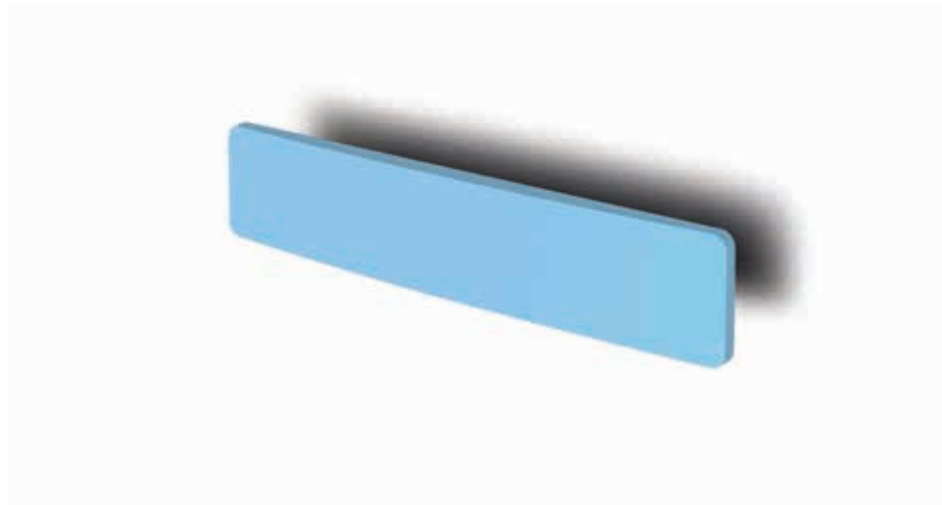

7194	Ref.	A	B	C	D
	7194.0128	128	210	20	40

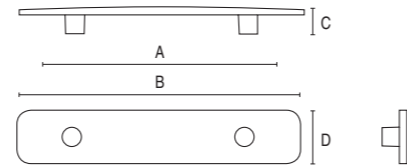

K718	Ref.	A	B	C	D
	K718.0128	128	270	15	60

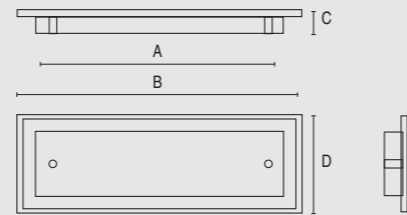

K719	Ref.	A	B	C	D
	K719.0128	128	270	15	60

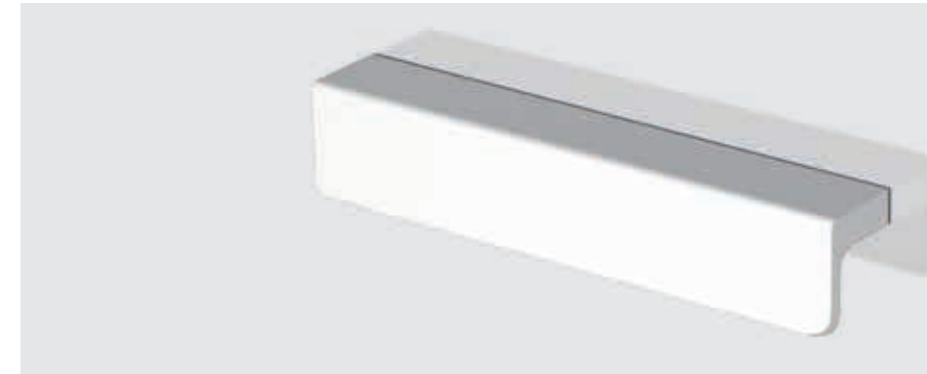
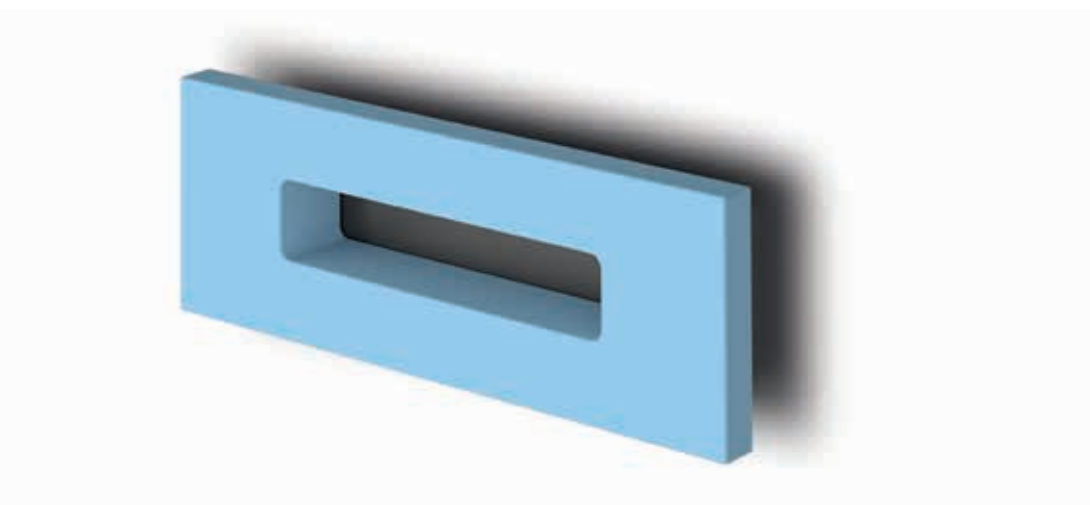
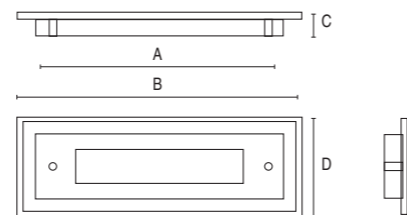

K720	Ref.	A	B	C	D
	K720.0130	32-96	130	20	30

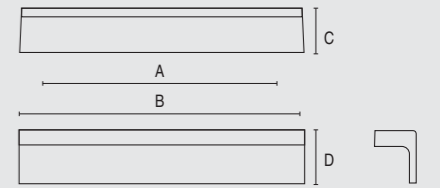

7110	Ref.	A	B	C	D
	7110.0064	64	100	17	25
	7110.0160	160	192	17	25

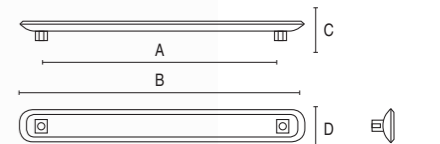

1014	Ref.	A	B	C	D
	1014.0040	-	40	24	40

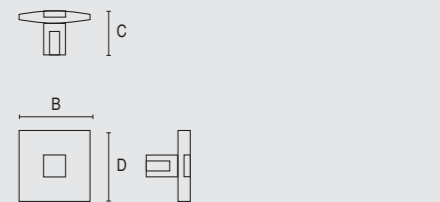
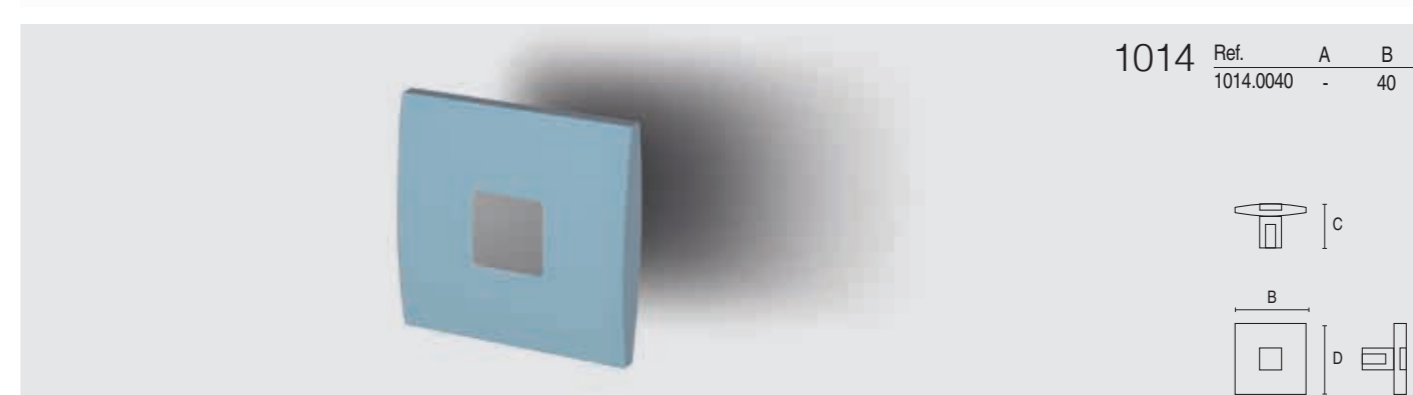

1A30 Ref. A B C
1A30.0015 - 15 26

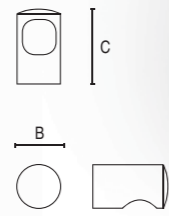

CUP 1046 Ref. A B C
1046.0070 32 70 27

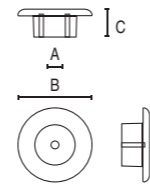

1042 Ref. A B C D
1042.0025 - 25 16 19

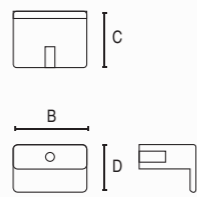

1045 Ref. A B C
1045.0070 32 70 27

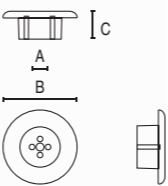
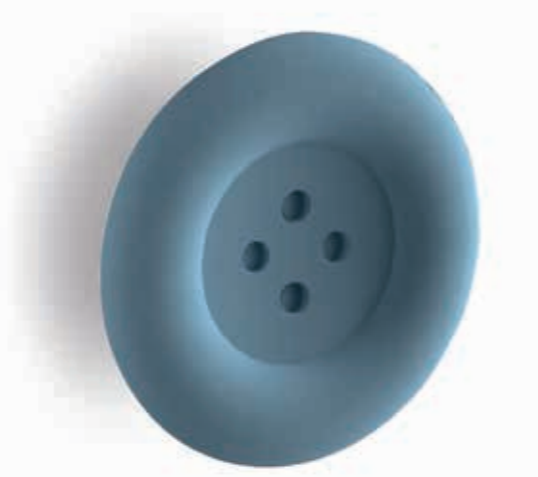

3019

Ref.	A	B	C	D
3019.0000	64	74	20	50
3019.0001	64	74	20	32
3019.0002	64	74	20	48
3019.0003	64	74	20	46
3019.0004	64	74	20	48
3019.0005	64	74	20	48
3019.0006	64	74	20	48
3019.0007	64	74	20	48
3019.0008	64	74	20	47
3019.0009	64	74	20	48

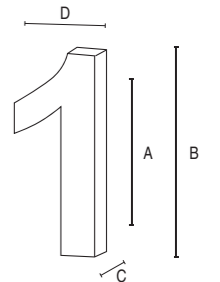

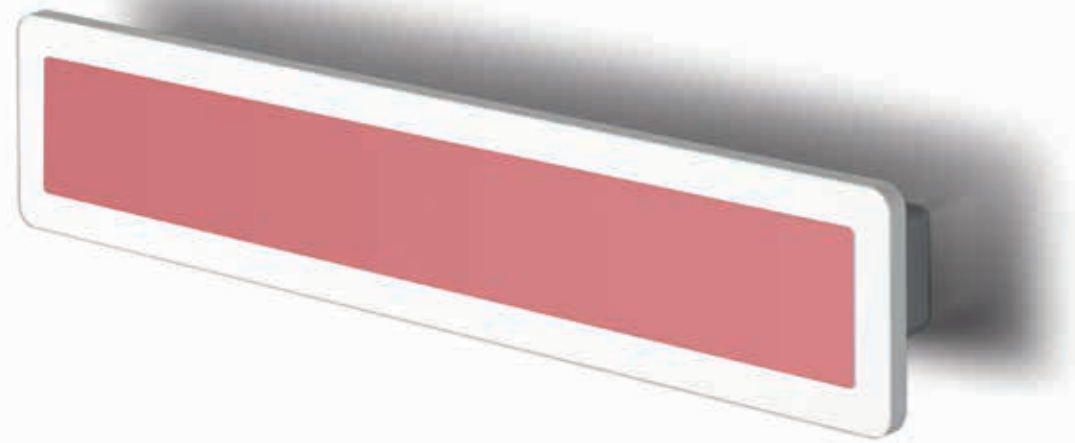

7210	Ref.	A	B	C	D
	7210.0160	160	250	27	50

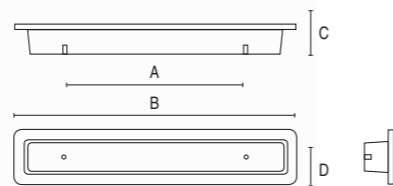

7100	Ref.	A	B	C	D
	7100.0110	64	110	16	8

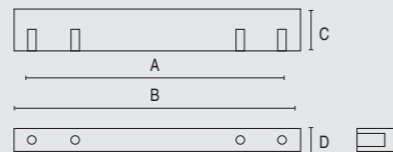
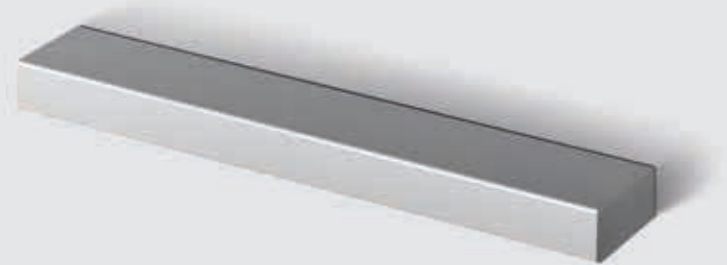

NA
 NAVARRO
 AZORÍN

CLASSIC





7690.0096	Ref.	A	B	C	D
7690.0096	7690.0096	96	127	21	23

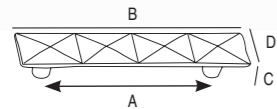

1691.0030	Ref.	A	B	C	D
1691.0030	-	30	22	-	-
1691.0025	-	25	21	-	-
1691.0020	-	20	20	-	-

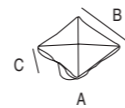

7690.0064	Ref.	A	B	C	D
7690.0064	7690.0064	64	94	21	23

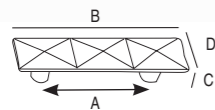

7690.0032	Ref.	A	B	C	D
7690.0032	7690.0032	32	64	21	23

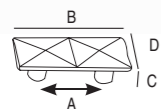

1A26	Ref.	A	B	C	
1A26.0025	-	Ø25	15	40	
1A26.0035	-	Ø35	15	40	

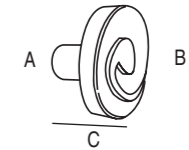

7208	Ref.	A	B	C	D
7208.0128	-	128	140	17	35
7208.0064	-	64	90	17	35

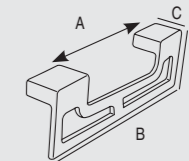

7211	Ref.	A	B	C	D
7211.0032	-	32	55	17	-
7211.0016	-	16	40	12	-

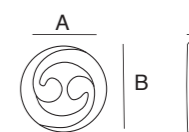

PIRAMIDE

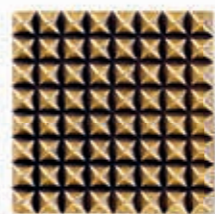

7249	Ref.	A	B	C	D
	1033.0064	32	64	33	-
	7249.0192	192	200	33	32
	7249.0288	288	293	33	32

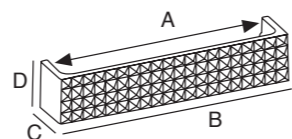
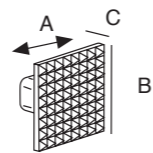

1028	Ref.	A	B	C	D
	1028.0025	-	25	25	25
	7227.0096	96	116	23	20
	7227.0160	160	180	23	20

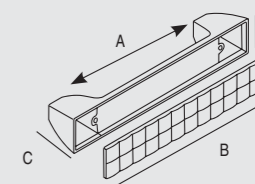
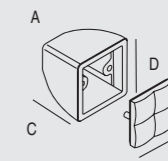

7217	Ref.	A	B	C	D
	7217.0032	32	50	16	35
	7217.0064	64	140	16	35
	7217.0096	64/96	200	16	35

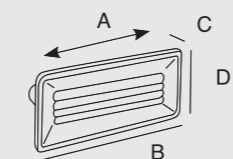

1027	Ref.	A	B	C	D
	1027.0025	-	25	25	25
	7226.0160	160	180	23	20
	7226.0096	96	116	23	20

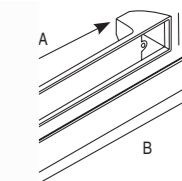
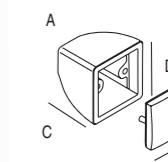

7214

Ref.	A	B	C	D
7214.0016	16	45	15	35
7214.0032	32	100	15	40

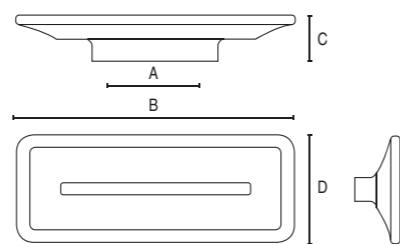

7213

Ref.	A	B	C	D
7213.0016	16	46	15	35
7213.0032	31	100	15	40

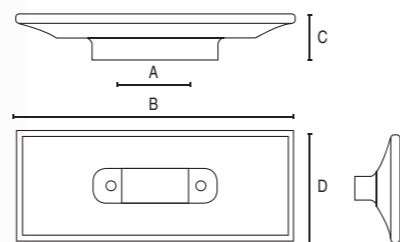

7002

Ref.	A	B	C	D
7002.0096	96	127	21	23
7002.0064	64	94	21	23

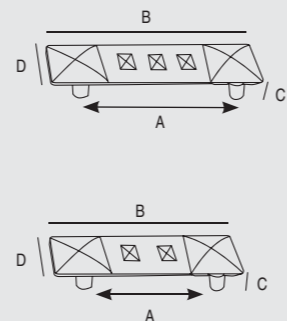

7C59.0064

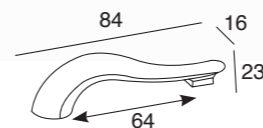

REIHN 7319

Ref.	A	B	C	D
7319.0125	96	125	20	32
7319.0200	128	200	20	32

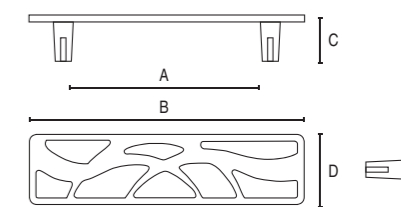

OVUM



7381

Ref.	A	B	C	D
7381.0128	128	148	22	48

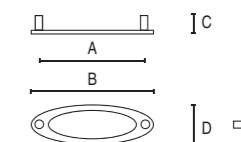

7174

Ref.	A	B	C	D
7174.0038	-	38	14	-

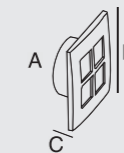

Ref.	A	B	C	D
7174.0060	16	60	22	-

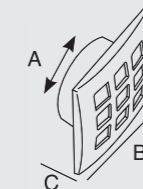

Ref.	A	B	C	D
7172.0096	96	128	18	15

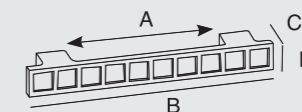



7476.0064

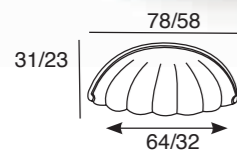

7476.0032



7752.0064

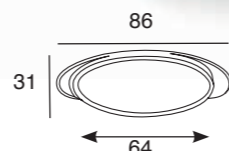

7479.0096

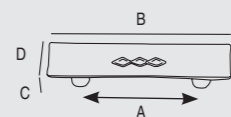
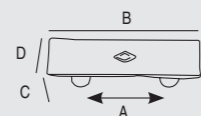
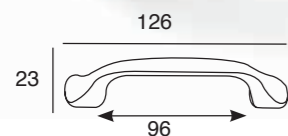

7790

Ref.	A	B	C	D
7790.0064	64	94	20	23
7790.0096	96	127	20	23

1560

Ref.	A	B	C	D
1560.0030	-	30	20	-
1560.0025	-	25	20	-



1482.0039

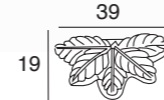

2368.0035



3381.0065

Ref.	A	B	C	D
3381.0065	-	45	65	-



2229.0080

Ref.	A	B	C	D
2229.0080	-	80	38	-

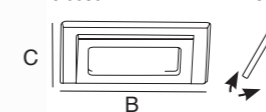

2371.0032

Ref.	A	B	C	D
2371.0032	-	76	46	-

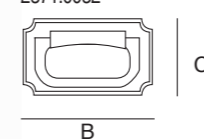

7241.0106

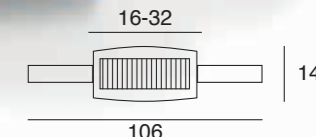

4799.0066

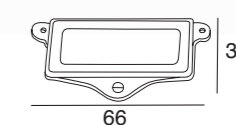

4767.0070

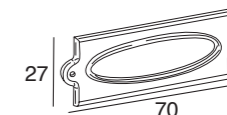



6685.0098 1684.0030
6685.0061 1684.0030

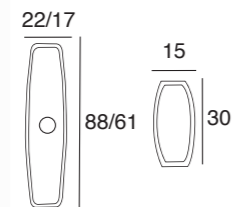

3682.0120
3682.0098

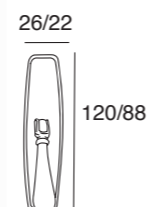

3589.0165.B
3589.0124.A

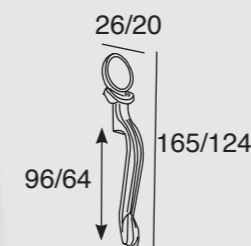

7588.0064
7588.0032

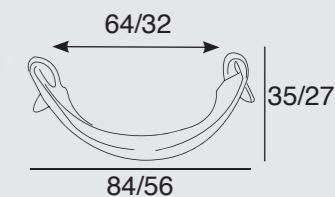

2681.0120

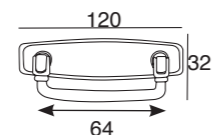

3714.0065
3712.0055

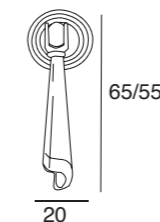

2681.0032

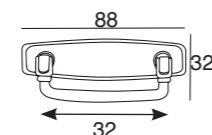

7710.0064

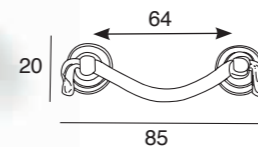

3713.0135.B
3711.0098.B

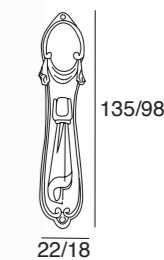



3451.0190.B

6453.0190
1436.0025

6454.0190

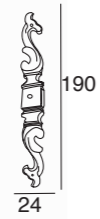

3451.0144.A

6453.0144
1436.0020

6454.0144



3727.0060



3246.0063

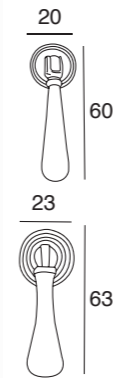

3760.0163.A
3761.0123.A

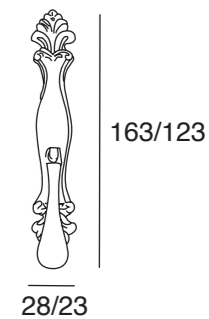

2762.0096
2762.0064

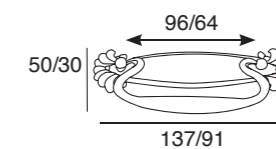

1436.0025

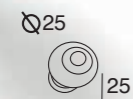

2449.0064

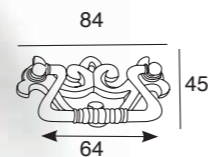



3771.0103.A
1768.0025

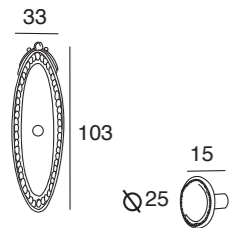

3770.0128.B

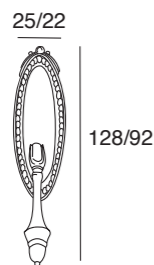

3769.0092.A



3812.0084
3812.0064

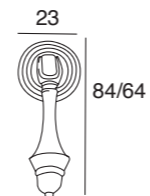

3367.0160.B
3366.0130.A

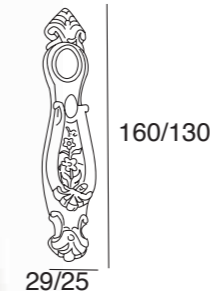

2365.0068
2364.0054

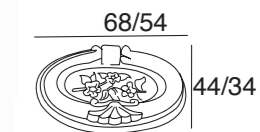

2771.0096
2771.0064

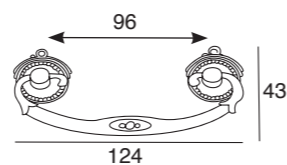

2580.0036

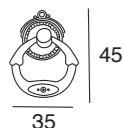

1768.0025

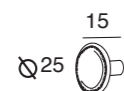

2490.0085
2490.0055
2489.0040

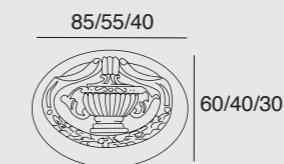

3492.0150.B
3491.0110.A





3175.0135.A
3174.0106.A

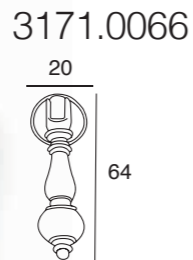
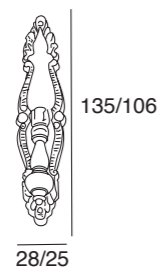

2173.0134
2172.0032

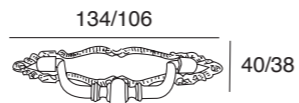

3221.0180.B
3221.0150.A
3219.0110.A

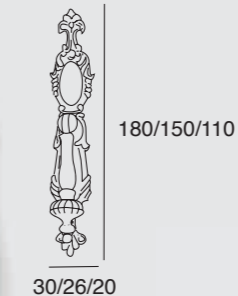

2218.0127
2218.0064

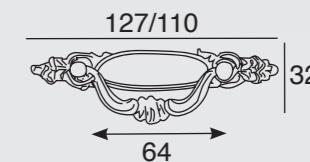

2292.0064
2291.0053

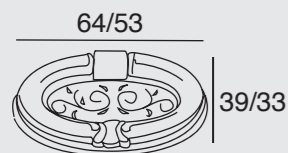

2293.0064

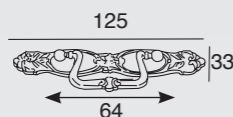

3295.0170.B
3294.0133.A



1091.0040
1091.0030
1091.0025

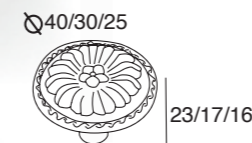

1109.0035
1109.0030

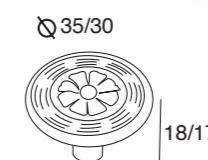

1126.0035
1126.0030

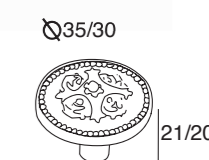



1397.0040

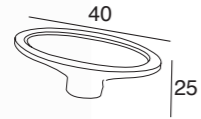

1397.0018

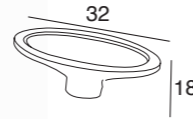

1031

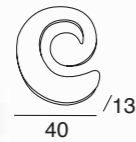

1038

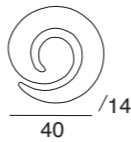

1026.0035

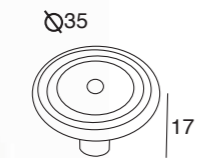

1726.0032

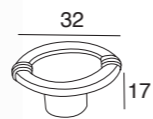

LUXURY

MILETUS



7162	Ref.	A	B	C	D	
	7162.0096	96	128	15	18	25

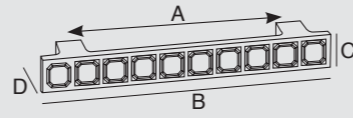

ATTICA



7165	Ref.	A	B	C	D	
	7165.0045	16-16	45	16	16	25

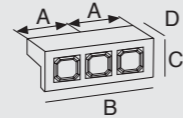

DELOS



7164	Ref.	A	B	C	D	
	7164.0060	16	60	20	-	15

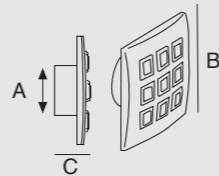

DELOS



7164	Ref.	A	B	C	D	
	7164.0038	-	38	14	-	25

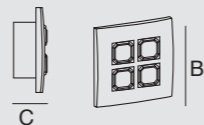

7182	Ref.	A	B	C	D	
	7182.0064	64	116	13	47	25

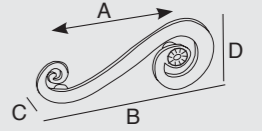

7183	Ref.	A	B	C	D	
	7183.0064	64	116	13	47	25

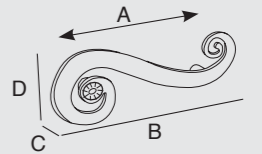

1039	Ref.	A	B	C	D	
	1039.0040	-	40	13	-	25



1032	Ref.	A	B	C	D	
	1032.0040	-	40	13	-	25

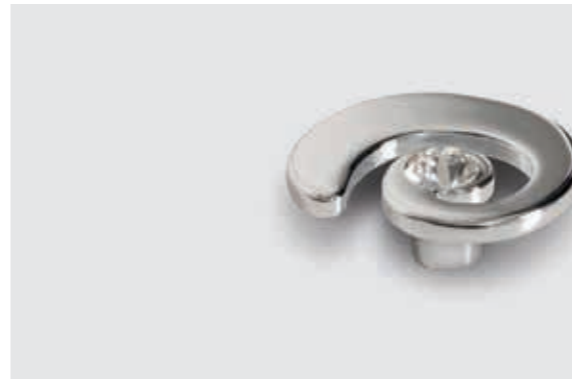

SULLY

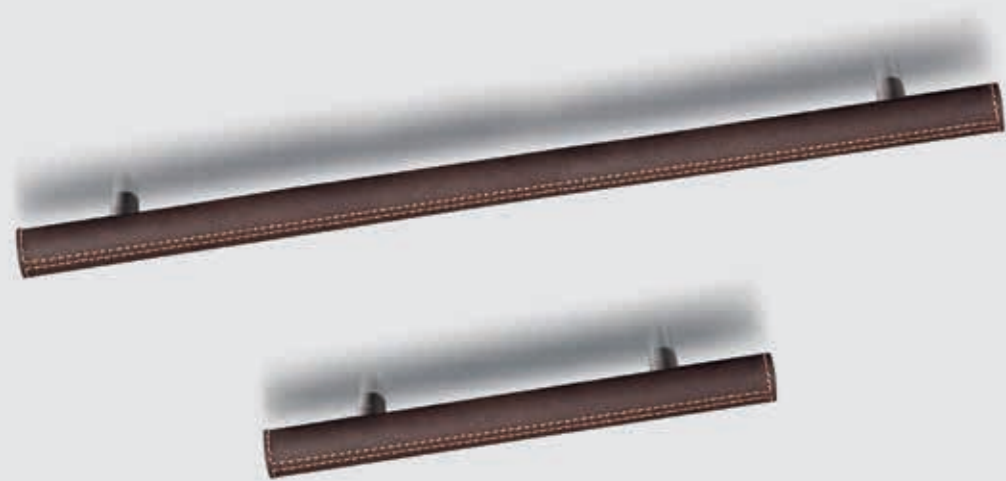

7524

Ref.	A	B	C	D	
7524.0128	128	210	41	19	10
7524.0320	320	402	41	19	10
7524.0544	544	626	41	19	10

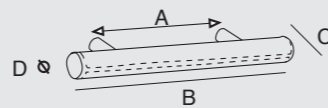

7783

Ref.	A	B	C	D	
7783.0104	64	104	19	23	10
7783.0200	64	200	19	23	10
7783.0400	192	400	19	23	10

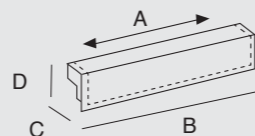

PIRAMIDE

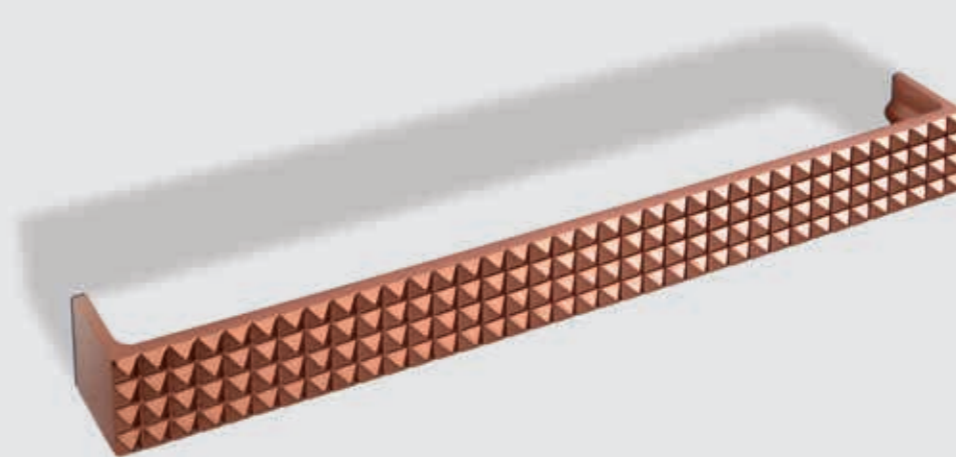

7249

Ref.	A	B	C	D	
7249.0288	288	296	33	32	10
7249.0192	192	200	33	32	10

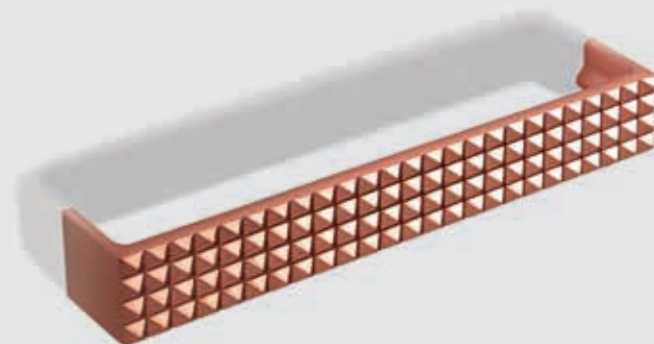
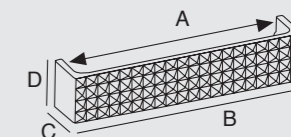

1033

Ref.	A	B	C	D	
1033.0064	32	64	33	-	10

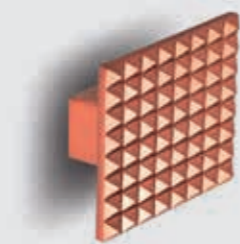
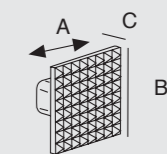

LATTICE

7317	Ref.	A	B	C	D	
	7317.0300	192	300	21	70	6
	7317.0500	192-192	500	21	70	6
	7317.0700	288-288	700	21	70	4

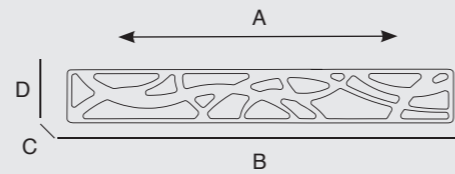

NA
 NAVARRO
 AZORIN

ACCESORIOS

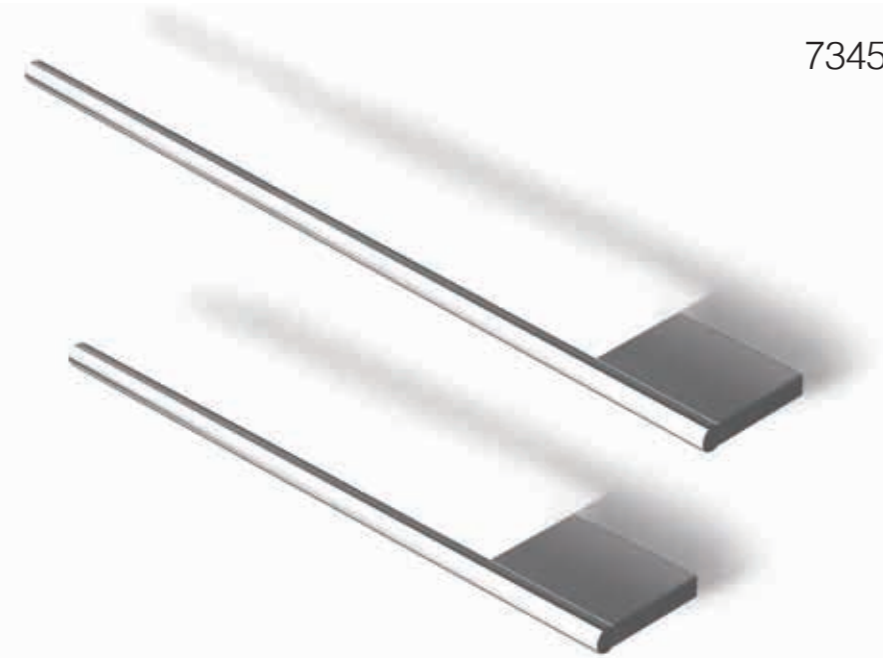

7345

Ref.	A	B	C	D	E	
7345.0350	50	350	59,3	12	70	25
7345.0450	50	450	59,3	12	70	25

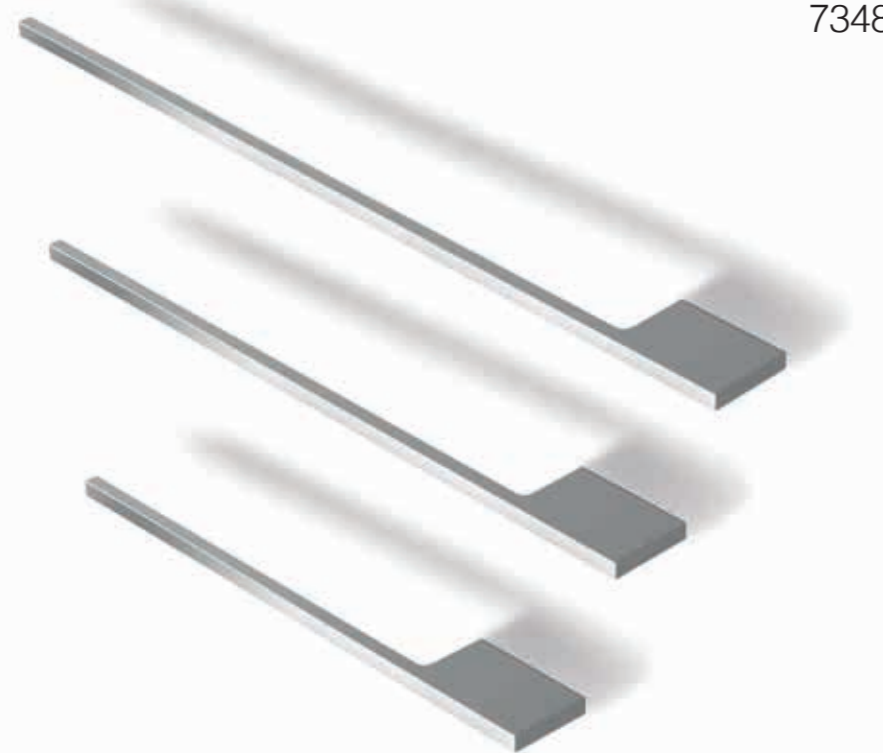
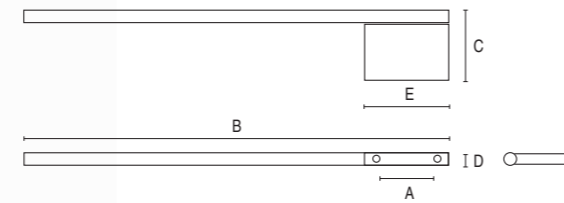

7348

Ref.	A	B	C	D	E	
7348.0350	50	350	50	10	70	25
7348.0450	50	450	50	10	70	25
7348.0550	50	550	50	10	70	25

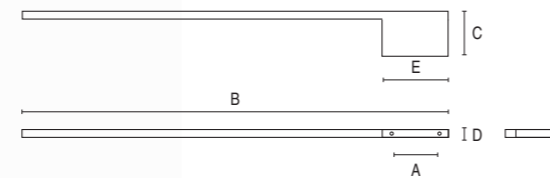

5080

Ref.	A	B	C	D	
5080.0150	-	87	96	150	15

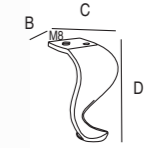

M709

Ref.	A	B	C	D	
M709.0300	192	300	15	30	10

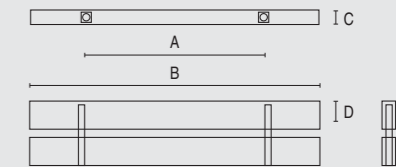

M706

Ref.	A	B	C	D	
M706	-	-	-	-	10

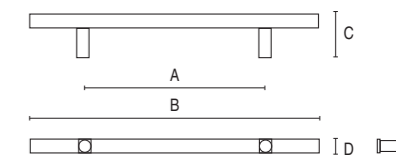

Ref.	pag.	Ref.	pag.	Ref.	pag.	Ref.	pag.
1003	51	2365	83	3812	82	7217	72
1014	65	2368	77	4767	77	7224	48
1017	52	2371	77	4799	77	7229	16
1023	52	2449	80	5080	95	7232	42
1026	86	2489	83	6453	80	7233	18
1027	73	2490	83	6454	80	7234	58
1028	73	2580	82	6685	78	7235	30
1031	52	2681	78	7001	43	7236	62
1031	86	2762	81	7002	74	7239	14
1032	89	2771	82	7003	39	7240	14
1033	91	3013	55	7004	41	7241	77
1036	52	3019	67	7006	44	7242	20
1037	50	3020	59	7020	26	7245	15
1038	50	3021	56	7021	34	7246	15
1038	86	3022	59	7030	23	7248	57
1039	89	3023	60	7031	26	7249	72
1040	50	3026	59	7061	58	7249	91
1041	50	3027	60	7067	19	7250	37
1042	66	3028	56	7069	17	7254	45
1043	50	3029	54	7091	63	7258	9
1045	66	3171	84	7093	17	7264	8
1046	66	3174	84	7100	68	7269	40
1091	85	3175	84	7110	65	7271	45
1105	50	3219	85	7111	41	7274	19
1109	85	3221	85	7154	16	7275	9
1116	51	3246	81	7162	88	7276	43
1126	85	3294	84	7164	88	7278	13
1324	52	3295	84	7165	88	7279	18
1397	86	3366	83	7170	31	7287	18
1436	80	3367	83	7171	13	7289	25
1436	80	3381	77	7174	75	7290	20
1468	52	3451	80	7180	47	7291	62
1482	77	3451	80	7181	47	7292	45
1560	76	3491	83	7182	89	7295	20
1691	70	3492	83	7183	89	7297	60
1726	86	3589	79	7191	14	7298	42
1768	82	3682	78	7192	16	7299	40
1768	82	3711	79	7193	32	7314	10
1784	51	3712	79	7194	64	7315	12
1798	52	3713	79	7196	63	7316	32
2172	84	3714	79	7208	71	7317	92
2173	84	3727	81	7210	68	7319	46
2218	85	3760	81	7211	71	7319	75
2229	77	3761	81	7212	31	7321	38
2291	84	3769	82	7213	74	7323	35
2292	84	3770	82	7214	74	7326	23
2293	84	3771	82	7215	22	7327	30
2364	83	3775	57	7216	16	7328	24

Ref.	pag.	Ref.	pag.
7329	30	8080	11
7330	37	1A26	71
7334	58	1A30	66
7339	62	3A56	56
7341	23	7B63	63
7342	39	7B79	19
7344	25	7B90	19
7345	94	7C08	17
7348	94	7C10	17
7362	26	7C59	75
7363	25	7C95	12
7364	24	K301	58
7365	55	K716	63
7366	29	K718	64
7370	55	K719	64
7371	35	K720	65
7374	36	M706	95
7375	22	M709	95
7381	46		
7381	75		
7382	22		
7384	24		
7388	15		
7389	19		
7390	28		
7391	40		
7392	15		
7393	28		
7394	34		
7396	26		
7397	54		
7399	54		
7476	76		
7479	76		
7524	90		
7579	44		
7588	79		
7690	70		
7694	20		
7710	79		
7720	38		
7742	36		
7744	57		
7752	76		
7783	18		
7783	90		
7790	76		
7797	14		



NA NAVARRO
AZORÍN

Navarro Azorín, S.L.
Camino de Sax, s/n · Apdo. / P.O. Box: 73 · 30510 YECLA (Murcia) SPAIN
Telf.: +34 968 751 425 · Fax: +34 968 795 599
www.na-spain.com · info@na-spain.com